

# MAGNAVOX

SMART. VERY SMART.

*Owner's Manual*

## **TB100MW9**

### *DTV Digital to Analog Converter (Set Top Box)*



**THANK YOU FOR CHOOSING MAGNAVOX.**

#### **NEED HELP FAST?**

READ YOUR OWNER'S MANUAL FIRST FOR QUICK TIPS  
THAT MAKE USING YOUR MAGNAVOX PRODUCT MORE ENJOYABLE.  
IF YOU HAVE READ YOUR INSTRUCTIONS AND STILL NEED ASSISTANCE,  
YOU MAY ACCESS OUR ONLINE HELP AT [HTTP://WWW.FUNAI-CORP.COM](http://www.funai-corp.com)  
OR CALL **1-800-605-8610** WHILE WITH YOUR PRODUCT.

**INSTRUCCIONES EN ESPAÑOL INCLUIDAS.**



Products that have earned ENERGY STAR® are designed to protect the environment through superior energy efficiency.

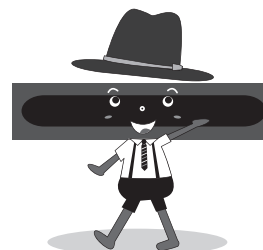

© 2008 Funai Electric Co., Ltd.

# Before Using

**WARNING:** TO REDUCE THE RISK OF FIRE OR ELECTRIC SHOCK, DO NOT EXPOSE THIS APPLIANCE TO RAIN OR MOISTURE.



**CAUTION:**  
TO REDUCE THE RISK OF ELECTRIC SHOCK, DO NOT REMOVE COVER (OR BACK). NO USER SERVICEABLE PARTS INSIDE. REFER SERVICING TO QUALIFIED SERVICE PERSONNEL.

The caution marking is located on the bottom of the cabinet.





THIS SYMBOL INDICATES THAT DANGEROUS VOLTAGE CONSTITUTING A RISK OF ELECTRIC SHOCK IS PRESENT WITHIN THIS UNIT.



THIS SYMBOL INDICATES THAT THERE ARE IMPORTANT OPERATING AND MAINTENANCE INSTRUCTIONS IN THE LITERATURE ACCOMPANYING THE APPLIANCE.

## Important Safeguards

- 1. Read instructions** - All the safety and operating instructions should be read before the appliance is operated.
- 2. Retain Instructions** - The safety and operating instructions should be retained for future reference.
- 3. Heed Warnings** - All warnings on the appliance and in the operating instructions should be adhered to.
- 4. Follow Instructions** - All operating and use instructions should be followed.
- 5. Cleaning** - Unplug this product from the wall outlet before cleaning. Do not use liquid cleaners or aerosol cleaners. Use a damp cloth for cleaning.  
**EXCEPTION:** A product that is meant for uninterrupted service and, that for some specific reason, such as the possibility of the loss of an authorization code for a CATV converter, is not intended to be unplugged by the user for cleaning or any other purpose, may exclude the reference to unplugging the appliance in the cleaning description otherwise required in item 5.
- 6. Attachments** - Do not use attachments not recommended by this product manufacturer as they may cause hazards.
- 7. Water and Moisture** - Do not use this product near water-for example, near a bath tub, wash bowl, kitchen sink, or laundry tub, in a wet basement, or near a swimming pool, and the like.
- 8. Accessories** - Do not place this product on an unstable cart, stand, tripod, bracket, or table. This product may fall, causing serious injury to someone, and serious damage to the appliance. Use only with a cart, stand, tripod, bracket, or table recommended by the manufacturer, or sold with this product. Any mounting of the appliance should follow the manufacturer's instructions and should use a mounting accessory recommended by the manufacturer. An appliance and cart combination should be moved with care. Quick stops, excessive force, and uneven surfaces may cause the appliance and cart combination to overturn.  
**AMEUBLES** - Cet appareil ne doit être placé que sur un meuble (avec ou sans roulettes) recommandé par le fabricant. Si vous l'installez sur un meuble à roulettes,  
  

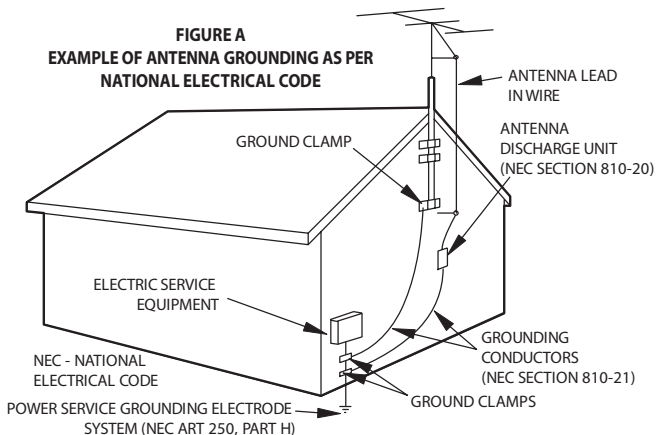
- 9. Ventilation** - Slots and openings in the cabinet and the back or bottom are provided for ventilation and to ensure reliable operation of this product and to protect it from overheating, and these openings must not be blocked or covered. The openings should never be blocked by placing this product on a bed, sofa, rug, or other similar surface. This product should never be placed near or over a radiator or heat register. This product should not be placed in a built-in installation such as a bookcase or rack unless proper ventilation is provided or the manufacturer's instructions have been adhered to.
- 10. Power Sources** - This product should be operated only from the type of power source indicated on the marking label. If you are not sure of the type of power supply to your home, consult your appliance dealer or local power company. For this products intended to operate from battery power, or other sources, refer to the operating instructions.
- 11. Grounding or Polarization** - This product is equipped with a polarized alternating-current line plug (a plug having one blade wider than the other). This plug will fit into the power outlet only one way. This is a safety feature. If you are unable to insert the plug fully into the outlet, try reversing the plug. If the plug should still fail to fit, contact your electrician to replace your obsolete outlet. Do not defeat the safety purpose of the polarized plug.
- 12. Power-Cord Protection** - Power-supply cords should be routed so that they are not likely to be walked on or pinched by items placed upon or against them, paying particular attention to cords at plugs, convenience receptacles, and the point where they exit from the appliance.
- 13. Outdoor Antenna grounding** - If an outside antenna or cable system is connected to this product, be sure the antenna or cable system is grounded so as to provide some protection against voltage surges and built-up static charges. Article 810 of the National Electrical Code, ANSI/NFPA No. 70, provides information with respect to proper grounding of the mast and supporting structure, grounding of the lead-in wire to an antenna discharge unit, size of grounding



conductors, location of antenna-discharge unit, connection to grounding electrodes, and requirements for the grounding electrode. (Fig. A)

- 14. Lightning** - For added protection for this product receiver during a lightning storm, or when it is left unattended and unused for long periods of time, unplug it from the wall outlet and disconnect the antenna or cable system. This will prevent damage to this product due to lightning and power-line surges.
- 15. Power Lines** - An outside antenna system should not be located in the vicinity of overhead power lines or other electric light or power circuits, or where it can fall into such power lines or circuits. When installing an outside antenna system, extreme care should be taken to keep from touching such power lines or circuits as contact with them might be fatal.
- 16. Overloading** - Do not overload wall outlets and extension cords as this can result in a risk of fire or electric shock.
- 17. Object and Liquid Entry** - Never push objects of any kind into this product through openings as they may touch dangerous voltage points or short out parts that could result in a fire or electric shock. Never spill liquid of any kind on this product.
- 18. Servicing** - Do not attempt to service this product yourself as opening or removing covers may expose you to dangerous voltage or other hazards. Refer all servicing to qualified service personnel.
- 19. Damage Requiring Service** - Unplug this product from the wall outlet and refer servicing to qualified service personnel under the following conditions:

- a. When the power-supply cord or plug is damaged or frayed.
- b. If liquid has been spilled, or objects have fallen into this product.
- c. If this product has been exposed to rain or water.
- d. If this product does not operate normally by following the operating instructions. Adjust only those controls that are covered by the operating instructions, as improper adjustment of other controls may result in damage and will often require extensive work by a qualified technician to restore this product to its normal operation.
- e. If this product has been dropped or damaged in any way.
- f. When this product exhibits a distinct change in performance-this indicates a need for service.

**20. Replacement Parts** - When replacement parts are required, be sure the service technician has used replacement parts specified by the manufacturer that have the same characteristics as the original part. Unauthorized substitutions may result in fire, electric shock, injury to persons or other hazards.

**21. Safety Check** - Upon completion of any service or repairs to this product, ask the service technician to perform routine safety checks to determine that this product is in proper operating condition.

**22. Heat** - This product should be situated away from heat sources such as radiators, heat registers, stoves, or other products (including amplifiers) that produce heat.

The serial number of this product may be found on the bottom of the unit. You should record the number and other vital information here and retain this book as a permanent record. Serial numbers are not kept on file.

Date of Purchase		Dealer Phone No.	
Dealer Purchase from		Model No.	
Dealer Address		Serial No.	

**CAUTION:** TO PREVENT ELECTRIC SHOCK, MATCH WIDE BLADE OF PLUG TO WIDE SLOT, FULLY INSERT.

**ATTENTION:** POUR ÉVITER LES CHOCS ÉLECTRIQUES, INTRODUIRE LA LAME LA PLUS LARGE DE LA FICHE DANS LA BORNE CORRESPONDANTE DE LA PRISE ET POUSSER JUSQU'AU FOND.

Do not place the unit on the furniture that is capable of being tilted by a child and an adult leaning, pulling, standing or climbing on it. A falling unit can cause serious injury or even death.

# Before Using

## Precautions

### Location

For safe operation and satisfactory performance of this product, keep the following in mind when selecting a place for its installation:

- Shield it from direct sunlight and keep it away from sources of intense heat.
- Avoid dusty or humid places.
- Avoid places with insufficient ventilation for proper heat dissipation. Do not block the ventilation holes at the top and bottom of the product. Do not place the product on a carpet because this will block the ventilation holes.
- Install the product in a horizontal position.
- Avoid locations subject to strong vibration.
- Do not place this product near strong magnetic fields.
- Avoid moving this product to locations where temperature differences are extreme.

### Important Copyright Information

Unauthorized recording or use of broadcast television programming, video tape, film or other copyrighted material may violate applicable copyright laws. We assume no responsibility for the unauthorized duplication, use or other acts which infringe upon the rights of copyright owners.

**FCC WARNING- This equipment may generate or use radio frequency energy. Changes or modifications to this equipment may cause harmful interference unless the modifications are expressly approved in the instruction manual. The user could lose the authority to operate this equipment if an unauthorized change or modification is made.**

### Avoid the Hazards of Electrical Shock and Fire

- Do not handle the power cord with wet hands.
- Do not pull on the power cord when disconnecting it from an AC wall outlet. Grasp it by the plug.
- If by accident, water is spilled on your the product, unplug the power cord immediately and take the product to our Authorized Service Center for servicing.
- Do not place anything directly on top of the product.

### A Note about Recycling

This product's packaging materials are recyclable and can be reused. Please dispose of any materials in accordance with your local recycling regulations.

Batteries should never be thrown away or incinerated but disposed of in accordance with your local regulations concerning chemical wastes.

## Table of Contents

### Before Using

Important Safeguards .....	2
Precautions .....	4
Overview .....	6
Information on Digital Broadcasting .....	7
Accessories .....	7
Installing Batteries .....	7
Location of Controls .....	8

### Connections

Connecting to a TV without A/V Jacks .....	10
Connecting to a TV with A/V Jacks .....	10
Connecting to a Cable Box (Optional) .....	11
Connecting to Other Devices .....	12

### Initial Setup (Setup Wizard)

Initial Setup .....	13
---------------------	----

### Basic Operation

Selecting Channels on the STB .....	15
-------------------------------------	----

### Advanced Operation

Autoscan (Receiving Channels) .....	18
Adding/Deleting Channels .....	18
Adjusting Antenna .....	20
Selecting Display Mode .....	20
Setting the Time Zone and D.S.T (Daylight Saving Time) .....	21
V-chip Options .....	22
Closed Caption Options .....	25
Auto Power Down .....	26

### Others

Specifications .....	26
Troubleshooting .....	27

Warranty .....	Back Cover
----------------	------------

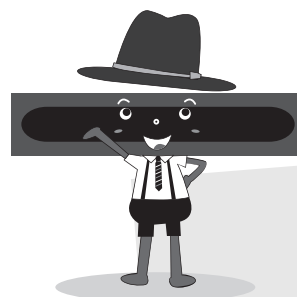

© 2008 Funai Electric Co., Ltd.

All rights reserved. No part of this manual may be reproduced, copied, transmitted, disseminated, transcribed, downloaded or stored in any storage medium, in any form or for any purpose without the express prior written consent of Funai. Furthermore, any unauthorized commercial distribution of this manual or any revision hereto is strictly prohibited.

Information in this document is subject to change without notice. Funai reserves the right to change the content herein without the obligation to notify any person or organization of such changes.

**FUNAI** with the  design is a registered trademark of Funai Electric Co., Ltd and may not be used in any way without the express written consent of Funai. All other trademarks used herein remain the exclusive property of their respective owners. Nothing contained in this manual should be construed as granting, by implication or otherwise, any license or right to use any of the trademarks displayed herein. Misuse of any trademarks or any other content in this manual is strictly prohibited. Funai shall aggressively enforce its intellectual property rights to the fullest extent of the law.

Manufactured under license from Dolby Laboratories. Dolby and the double-D symbol are trademarks of Dolby Laboratories.

# Before Using

## Overview

### CONNECTION

#### **A** Connecting to a TV without A/V jacks

Conexión a un TV sin tomas de A/V



#### **B** Connecting to a TV with A/V jacks

Conexión a un TV con tomas de A/V



#### **C** Connecting to a Cable Box

Conexión a una caja de cable

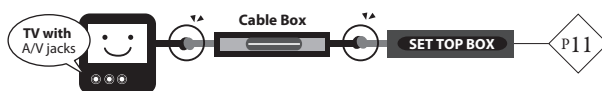

#### **D** Connecting to Other Devices

Conexión a otros dispositivos

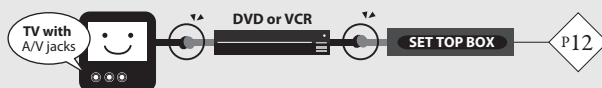

### SETUP WIZARD

- 1. Language for TV screen**  
Idioma para la pantalla
- 2. Connection for audio output**  
Conexión para salida de audio
- 3. Time zone**  
Husos horarios
- 4. Daylight savings time (D.S.T)**  
Hora de verano (D.S.T)
- 5. Display mode**  
modo de indicaciones
- 6. Channel scanning**  
Búsqueda de canales

P14

## Information on Digital Broadcasting

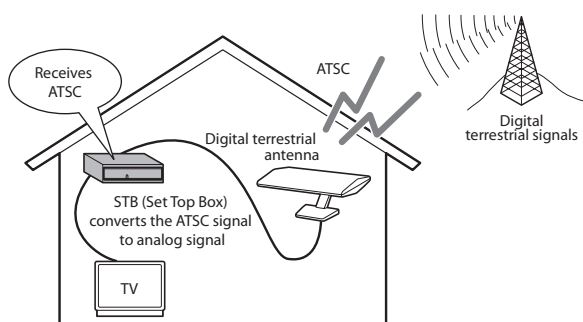

This STB makes it possible to view the digital TV programs on your analog TV by converting the digital signal to the analog signal. You can use most features provided by the digital broadcast, except that the resolution of the image is always output in 480i (standard resolution).

## Accessories

Check the following accessories when unpacking the STB:

Remote control:  
NA386UD (x1)

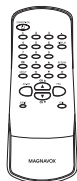

Owner's manual:  
1VMN25976 (x1)



AA battery (x2)



RF cable:  
WPZ0901TM002 /  
WPZ0901TM005 (x1)

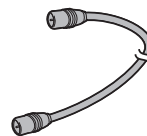

## Installing Batteries

Instalación de pilas

- 1 Unsnap the battery cover from the back of the remote control.**

Abra la cubierta de pilas de la parte trasera del mando a distancia.

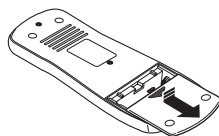

- 2 Install two AA batteries making sure the polarity (+ / -) is correct.**

Instale dos pilas AA asegurándose que la polaridad (+ / -) sea la correcta.

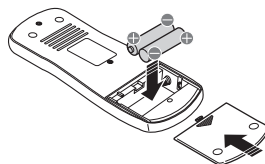

- 3 Snap the battery cover back.**

Cierre la cubierta de pilas.

### NOTE:

- When replacing batteries, replace them in pairs.

Quando cambie las pilas, hágalo por pares.

### CAUTION:

- Do not mix battery types (alkaline and manganese, or old ones and new ones).  
No mezcle tipos de baterías (baterías alcalinas y de manganeso, ni pilas viejas con pilas nuevas).
- Do not recharge, short-circuit, heat, burn or disassemble batteries.  
No recargue, caliente, queme o desarme baterías ni provoque un corto circuito con ellas.
- Remove batteries from battery compartment that is not going to be used for a month or more.  
Quite las pilas del compartimento de pilas si no se va a utilizar durante un mes o más.

# Before Using

## Location of Controls

Ubicación del control

### Remote Control

Mando a distancia

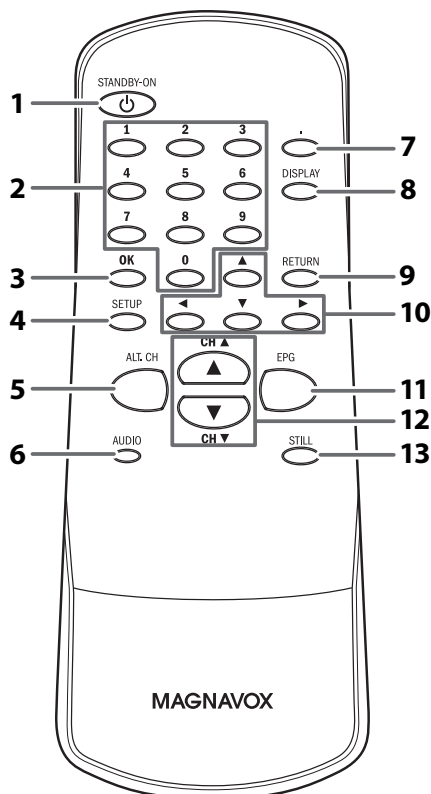

- 1 STANDBY-ON button:** Turns STB on and off.  
Conecta y desconecta el STB.
- 2 Number buttons**
- 3 OK button**
- 4 SETUP button:** Displays "SETUP" menu.  
Switches between ch3 / ch4 by holding this button down over 3 seconds.  
Despliega el menú "AJUSTE".  
Puede alternar entre el canal 3 y 4 si mantiene presionado [SETUP] durante 3 segundos.
- 5 ALT. CH:** Returns to the last selected channel.  
Regresa al último canal seleccionado.
- 6 AUDIO button:** Selects alternative audio languages (if available).  
Selecciona idiomas de audio alternativos (si existen).
- 7 . (Confirm) button:** Press to confirm the channel selection made by [the Number buttons].  
Presione para confirmar la selección del canal, hecha con [los botones de Números].
- 8 DISPLAY button:** Displays the channel banner.  
Despliega el banner del canal.
- 9 RETURN button:** Returns to the previous menu screen.  
Regresa a la pantalla de menú anterior.
- 10 Navigation buttons ▲ / ▼ / ◀ / ▶**
- 11 EPG button:** Displays the Electronic Program Guide.  
Despliega la Guía Electrónica de Programas.
- 12 CH ▲ / ▼ buttons**
- 13 STILL button:** Freezes the image on the TV screen.  
Congela la imagen de la pantalla del TV.

- To operate this STB with a universal remote, check the instruction manual for remote and find Magnavox brand STB code. If you do not find the code or the code does not work, try to use Sylvania brand STB code instead.



## Front Panel

Panel frontal

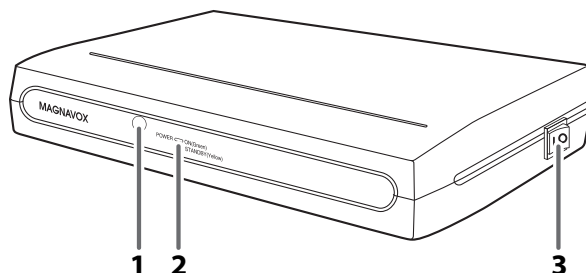

### 1 Remote control sensor

### 2 POWER indicator:

Turns green when the STB is in operation. Turns yellow on standby.

Se vuelve verde cuando el STB está en operación. Se vuelve amarilla en el modo en espera.

### 3 Main Power:

Turns STB's main power on and off.

Conecta y desconecta la fuente de alimentación principal del STB.



When you use this button to turn off the main power, make sure the Power indicator is yellow.

Cuando utilice este botón para desconectar la fuente de alimentación principal, asegúrese de que el indicador de potencia esté amarillo.

## Rear Panel

Panel trasero

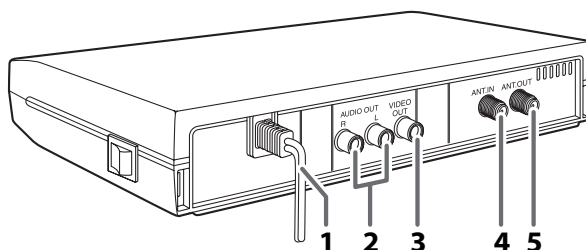

### 1 AC power cord

### 2 AUDIO OUT jacks (Right-red / Left-white):

Connect your TV, stereo system or VCR etc. with standard audio cables.

Conecte su TV, sistema estéreo o VCR, etc., con cables de audio estándares.

### 3 VIDEO OUT jack (yellow):

Connect your TV or VCR etc. with a standard video cable.

Conecte su TV o VCR, etc., con un cable estándar de video.

### 4 ANT. IN jack:

Connect an antenna.

Conecte una antena.

### 5 ANT. OUT jack:

Connect to the ANT. IN jack on your TV.

Conecte a la toma ANT. IN de su TV.

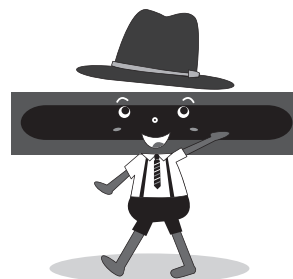

# Connections

- 1 Disconnect the AC power cords of the devices from the AC outlet.  
Desconecte los cables de alimentación de los aparatos del tomacorriente CA.
- 2 Disconnect RF coaxial cable from antenna input jack of your TV.  
Desconecte el cable coaxial de RF del conector hembra de entrada de antena de su televisor.
- 3 Make the connections as illustrated below.  
Efectúe las conexiones tal como se ilustra a continuación.
- 4 Plug all AC power cords into AC outlets, then turn all devices on.  
Enchufe todos los cables eléctricos de CA en los tomacorrientes de CA y conecte la alimentación de todos los equipos.

## **A** Connecting to a TV without A/V Jacks

Conexión a un TV sin tomas de A/V

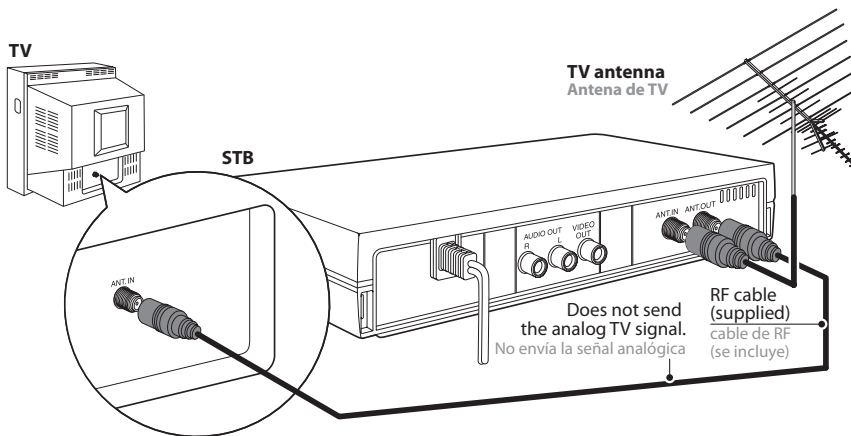

## **B** Connecting to a TV with A/V Jacks

Conexión a un TV con tomas de A/V

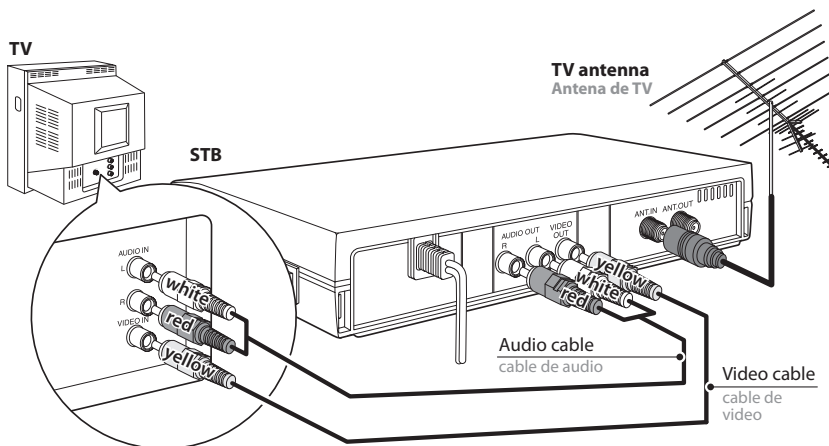

### NOTE:

- If your TV has only one audio jack, connect the AUDIO OUT jack (L) (white) on the STB to the audio input jack on the TV.  
Si su TV sólo tiene una toma de audio, conecte la toma AUDIO OUT (L) (blanco) del STB, a la toma de entrada de audio del TV.

## C Connecting to a Cable Box (Optional)

Conexión a una caja de cable (opcional)

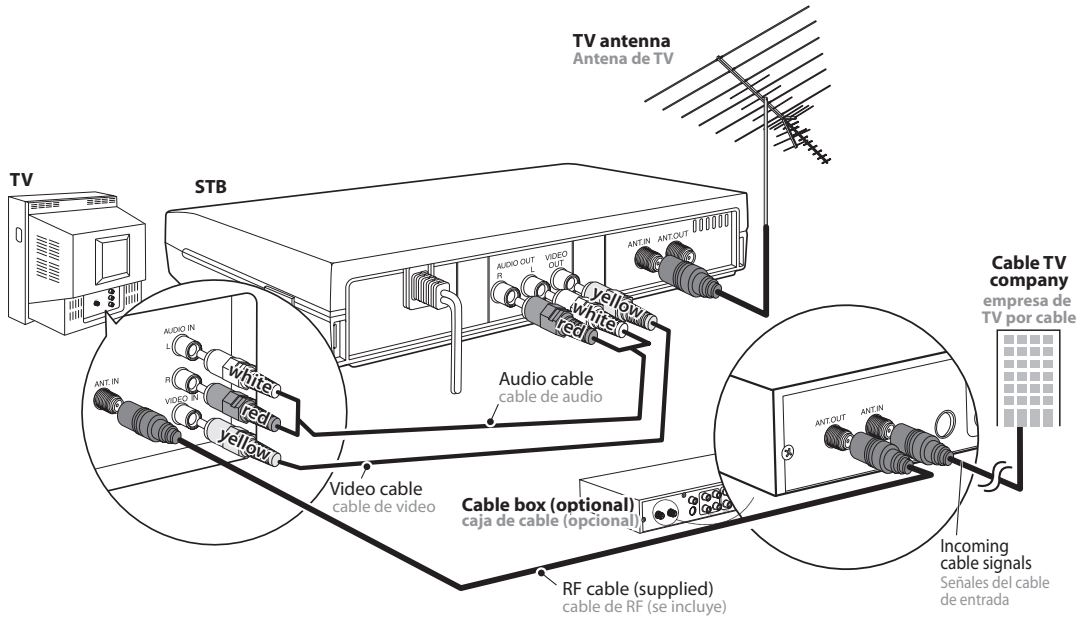

### Note to the Cable TV System Installer:

This reminder is provided to call the Cable TV system installer's attention to Article 820-40 of the National Electrical Code, which provides guidelines for proper grounding - in particular, specifying that the cable ground shall be connected to the grounding system of the building, as close to the point of cable entry as possible.

### Observación para el instalador del sistema de cable de TV:

Este recordatorio se provee para alertar al instalador del sistema de cable de TV sobre el Artículo 820-40 del Código Eléctrico Nacional, el cual proporciona pautas para una puesta a tierra adecuada, y en particular especifica que la puesta a tierra del cable debe estar conectada al sistema de puesta a tierra del edificio, lo más cerca posible del punto de entrada del cable.

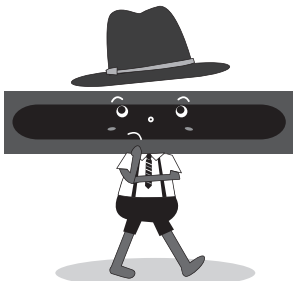

# Connections

## D Connecting to Other Devices

Conexión a otros dispositivos

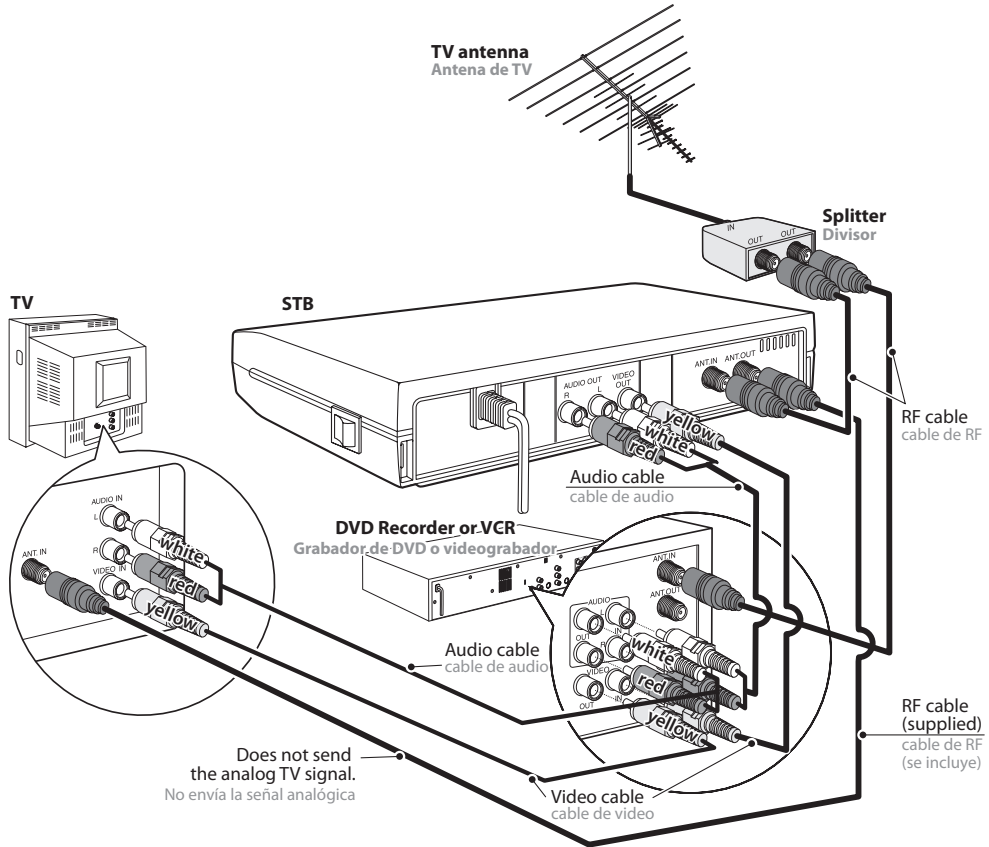

### NOTE:

- If your DVD recorder or VCR has only one audio jack, connect the AUDIO OUT jack (L) (white) on the STB to the audio input jack on the DVD.  
Si su grabador de DVD o videograbador sólo tiene una toma de audio, conecte la toma AUDIO OUT (L) (blanco) del STB, a la toma de entrada de audio del DVD.

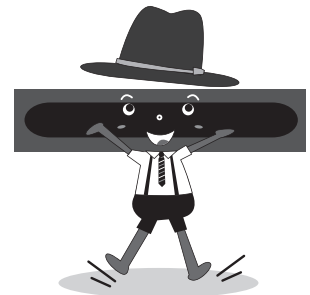

# Initial Setup (Setup Wizard)

## Initial Setup

Ajùste inicial

### 1 Switch the STB's mains power on.

Encienda la alimentación principal del STB.

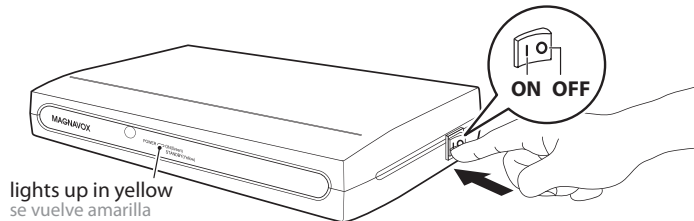

### 2 Press [STANDBY-ON] on the remote control to activate the STB.

Presione [STANDBY-ON] en el mando a distancia para activar el STB.

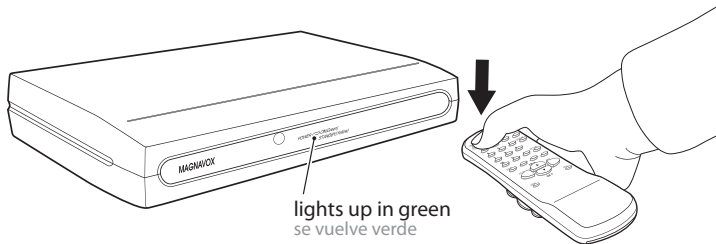

### 3 Turn on the TV, and select the viewing channel (ch3 or external input channel) on your TV. (Refer to your TV's manual.)

Encienda el TV, y seleccione el canal que quiera ver (canal 3 o uno de entrada externo) en su TV. (Véase el manual del TV.)

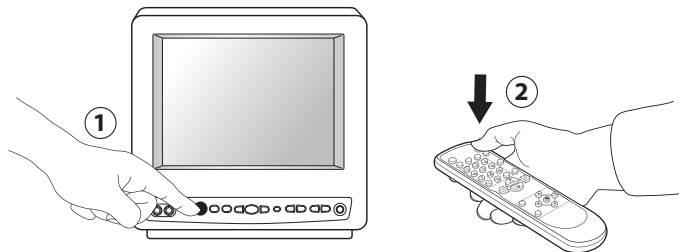

#### Appropriate Viewing Channel

Configuración apropiada de el Canal de Visión

Viewing Connection	STB	Cable Box	DVD or VCR
<b>A</b> (p.10)	"CH3"	—	—
<b>B</b> (p.10)	External input channel Canal de entrada externo	—	—
<b>C</b> (p.11)	External input channel Canal de entrada externo	Ch3	—
<b>D</b> (p.12)	"CH3"	—	External input channel Canal de entrada externo

- If your TV's ch3 is already occupied, select ch4, and set the STB's output channel to ch4. You can switch ch3 / ch4 by holding **[SETUP]** down over 3 seconds.  
Si el c3 de su TV ya está ocupado, seleccione el c4 y luego ajuste el canal de salida del STB a c4. Puede alternar entre el c3 y 4 manteniendo presionado **[SETUP]** durante 3 segundos.

"SETUP WIZARD" screen automatically appears.

Follow the directions shown on the TV screen to set the each setting.

# Initial Setup (Setup Wizard)

## 4 Select "CONTINUE" using [◀/▶], then press [OK].

Seleccione "CONTINUE" utilizando [◀/▶] y presione [OK].

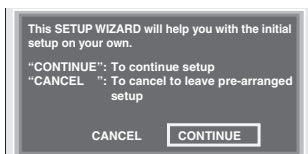

## 5 Select the language using [▲/▼], then press [OK].

Seleccione el idioma utilizando [▲/▼] y presione [OK].

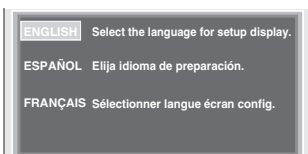

## 6 Select the connection for audio output using [◀/▶], then press [OK].

Seleccione la conexión para salida de audio mediante [◀/▶] y luego presione [OK].

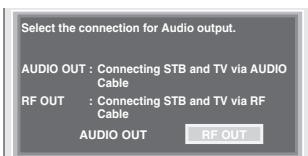

### Select "AUDIO OUT" if...

- you are using the standard audio cable to connect the STB to your TV. (Connection **B** or **C** on pages 10 and 11.)

### Seleccione "AUDIO FUERA" si...

- está utilizando el cable de audio normal para conectar el STB a su TV. (conexión **B** o **C** en las páginas 10 y 11.)

### Select "RF OUT" if...

- you are using the RF cable to connect the STB to your TV. (Connection **A** or **D** on pages 10 and 12.)

### Seleccione "RF FUERA" si...

- está utilizando el cable RF para conectar el STB a su TV. (conexión **A** o **D** en las páginas 10 y 12.)

## 7 Select your time zone using [▲/▼], then press [OK].

Seleccione su huso horario con [▲/▼] y presione [OK].

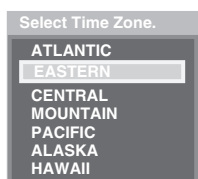

## 8 Select "ON" or "OFF" for Daylight Saving Time (D.S.T) using [◀/▶], then press [OK].

Seleccione "ON" u "OFF" para la hora de verano. (D.S.T) utilizando [◀/▶] y presione [OK].

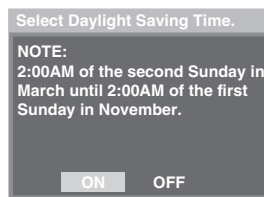

## 9 Select the desired display mode using [▲/▼], then press [OK] (refer to page 20).

Seleccione el modo de indicación deseado utilizando [▲/▼] y presione [OK].

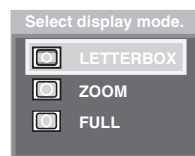

## 10 Select "AUTOSCAN" using [▲/▼], then press [OK].

Seleccione "AUTOEXPLO." mediante [▲/▼] y luego presione [OK].

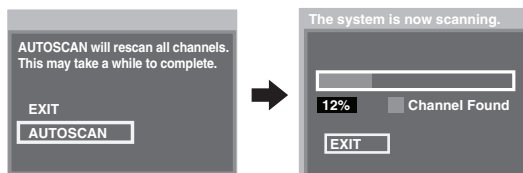

- STB starts receiving available digital channels and stores them in the channel map.
- When the scanning is complete, "AUTOSCAN COMPLETED" will be indicated.
- After autoscan is complete, use [CH ▲ / ▼] to verify whether STB is receiving channels properly.

**The "SETUP WIZARD" is now complete.**  
El "ASISTENTE DE PREP." ahora ha finalizado.

### To cancel during scanning:

Press [SETUP] or [OK].

Para cancelar durante la exploración: Presione [SETUP] o [OK].

- If autoscan is canceled, some channels not yet scanned may not be received. We recommend completing autoscan.
- You can do autoscan and adding / deleting channel later. Refer to page 18.

# Basic Operation

## About Sub-channel Broadcasting

Digital broadcasting offers a service that enables multiple signals, called "sub-channels", to be sent simultaneously on one main channel by using its high compression technology.

### ATSC

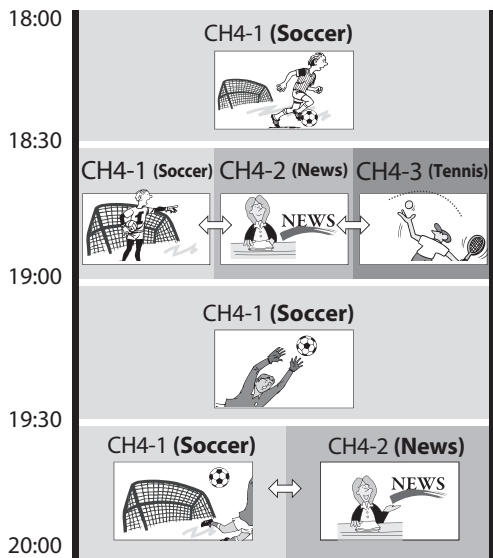

↔ : Can be changed by using [CH ▲/▼].

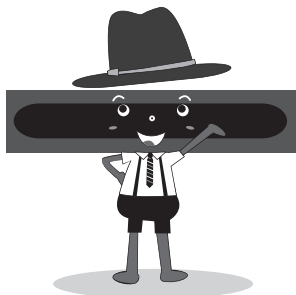

## Selecting Channels on the STB

### 1 Enter the main channel number.

If the main channel number is 1 digit, press [.] when finish entering.

### 2 Enter the sub-channel number.

If the sub-channel number is 1 digit, press [OK] when finish entering.

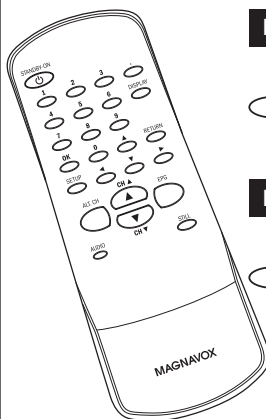

E.g., selecting 6.1



E.g., selecting 26.12



### NOTE:

- If you do not have a particular sub-channel number you want to select, enter the main channel number and then press [OK]. (If the main channel number is 1 digit, you should press [OK] twice.) The STB automatically tunes into the lowest sub-channel for the selected main channel.
- Press [ALT. CH] to return to the previously viewed channel.
- "NO SIGNAL" appears after the sub-channel broadcast is over.

# Basic Operation

## Choosing Audio Language

You can change languages when the channel provides alternate languages.

Press **[AUDIO]** repeatedly.

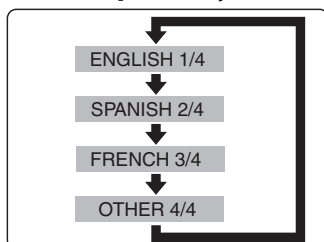

- Audio language changes as follows.

### NOTE:

- "OTHER" is indicated when the language is not English, Spanish nor French.
- For international stations audio language will still be displayed as English.

## Picture Still

You can freeze the image on the TV screen.

Press **[STILL]**.

The image on the TV screen will be paused.

**To cancel still mode:**

Press any button except **[STANDBY-ON]**.

### NOTE:

- The sound output will not be paused.
- If "no signal" is detected or protected signal is received during still mode, the image remains paused and the sound output will be muted.
- If the TV is left on STILL for a long period of time, the still image may cause a burn-in effect damaging the TV screen.

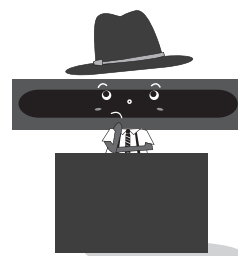
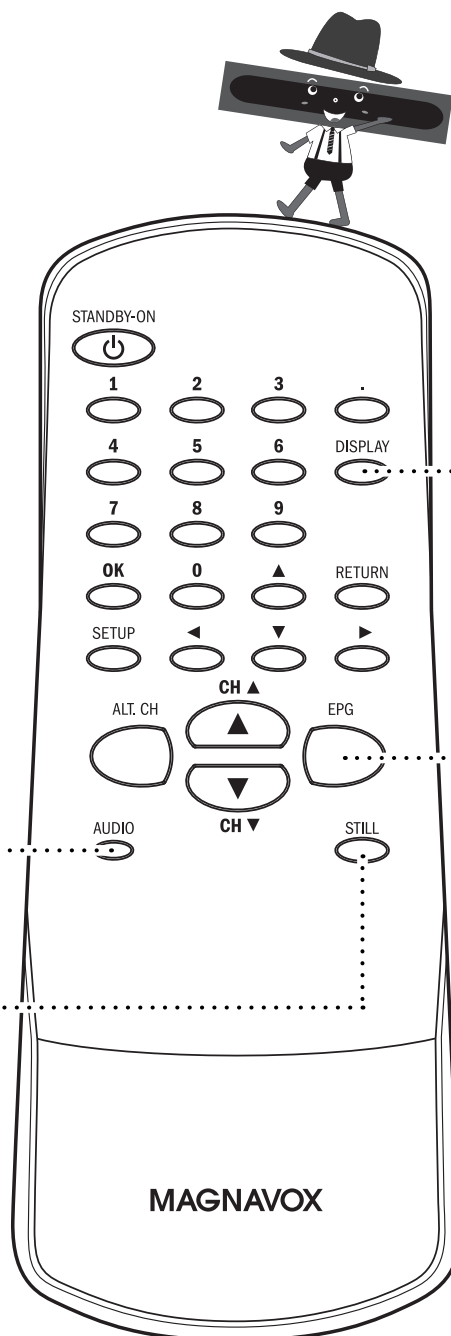



## Channel Banner

The channel banner provides you with the information on the selected channel.

Press [DISPLAY].

### Information Icons



**CC (Closed Caption):**

Indicates that the program being broadcast is available with closed captioning.



**LOCK:**

Indicates that the current program is blocked according to your V-chip setting.

Program title

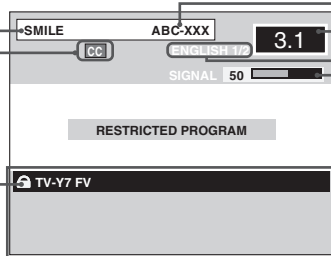

Station name

Channel number :

Audio language

Signal strength :

Indicates the signal strength of the current channel.

Program ratings :

Displays all the available ratings. Active ratings are highlighted in red.

**To remove the channel banner:**

Press [DISPLAY].

## Electronic Program Guide (EPG)

Electronic Program Guide (EPG) is the electronic equivalent of a printed TV program guide.

You can view a list of programs scheduled for the next few hours up to the next seven days.

To display the correct information on "EPG", "TIME ZONE" and "D.S.T" must be set correctly.

### 1 Press [EPG] while watching TV.

Program title

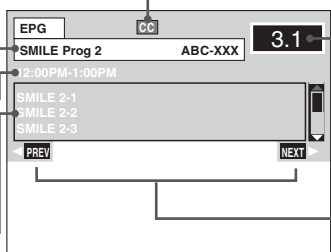

Time segment for the program. "NOW" icon will be displayed on the right for the current program.

Program description

Closed Caption :

Indicates that the program being broadcast is available with closed captioning.

Channel number

Indicates that there is a program information available for next or previous program.

### 2 Select the desired program using [◀/▶].

**To remove the EPG:**

Press [EPG].

**NOTE:**

- "EPG" will be cleared after 5 minutes.
- For channel numbers with blank description, the broadcasting station may not provide signals for "EPG".
- When the program description consists of more than 4 lines, use [▲/▼] to scroll up / down in the list.

# Advanced Operation

## Autoscan (Receiving Channels)

Autoscan receives available digital channels and stores them in a channel map.

### CAUTION:

- If autoscan is skipped, digital channels may not be received correctly.

- 1 Press [SETUP].
- 2 Select "CHANNEL" using [▲ / ▼], then press [OK].
- 3 Select "AUTOSCAN" using [▲ / ▼], then press [OK].

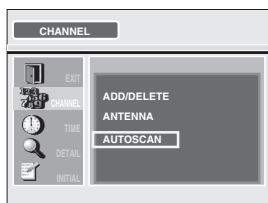

- 4 Select "AUTOSCAN" using [▲ / ▼], then press [OK].

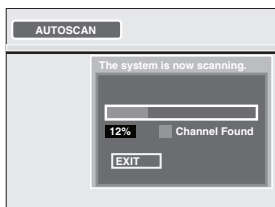
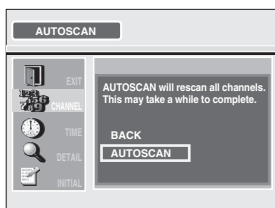

- STB starts receiving available digital channels and stores them in the channel map.
- When the scanning is complete, "AUTOSCAN COMPLETED" will be indicated.
- After autoscan is complete, use [CH ▲ / ▼] to verify whether STB is receiving channels properly.

### To cancel during scanning:

Press [SETUP] or [OK].

### NOTE:

- If canceled, some channels not yet scanned may not be received. We recommend completing autoscan.
- When you want to completely refresh the channel map, delete all the channels, then do the autoscan again. See "Adding/Deleting Channels" on this page for details.

### When "NO SIGNAL" appears on the TV screen:

Verify the antenna connection, then scan again.

The STB tunes in channel 2-1 and "NO SIGNAL" appears if the STB could not receive any channels.

## Adding/Deleting Channels

Add or delete desired channels in the channel map.

### CAUTION:

- You cannot recover the deleted channels once they are deleted unless you perform the autoscan again.

- 1 Press [SETUP].
- 2 Select "CHANNEL" using [▲ / ▼], then press [OK].

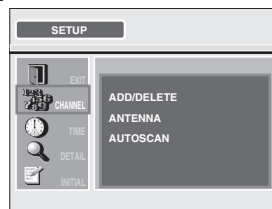

- 3 Select "ADD/DELETE" using [▲ / ▼], then press [OK].

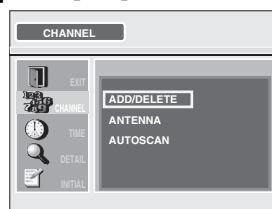

### Add

- With "ADD" selected, enter the main channel number you want to add, then press [OK] or wait for a few seconds to fix the number.

If the main channel number is 1 digit, press [0] first.

#### NOTE:

- Entering sub-channel number is not required.

- Press [OK] again to add the channel to the channel map.

E.g., adding channel 6

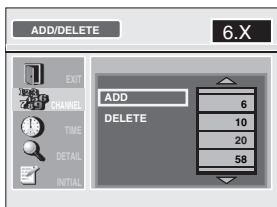
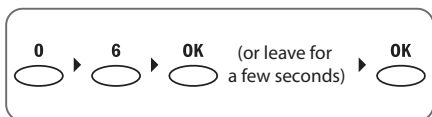

E.g., adding channel 26.

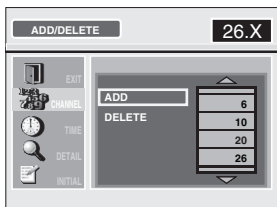
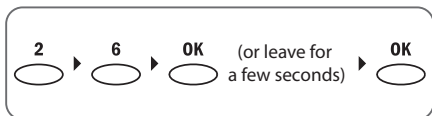

- The selected channel is now added.

#### To continue adding:

Repeat steps 4 and 5.

- Press [SETUP] to exit.

### Delete

- Select "DELETE" using [▲ / ▼], then press [OK].

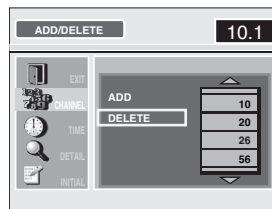

- Select the channel number you want to delete from the channel list on the right using [▲ / ▼], then press [OK].

E.g., deleting channel 26.

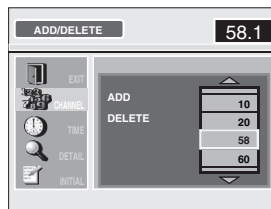
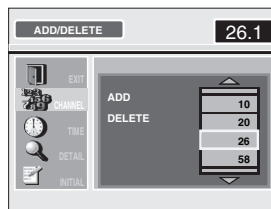

- The selected channel is now deleted.

#### To continue deleting:

Repeat step 5.

- Press [SETUP] to exit.

# Advanced Operation

## Adjusting Antenna

You can verify the signal strength of each channel.

- 1 Select a channel to adjust using [the Number buttons] or [CH ▲ / ▼].
- 2 Press [SETUP].
- 3 Select "CHANNEL" using [▲ / ▼], then press [OK].
- 4 Select "ANTENNA" using [▲ / ▼], then press [OK].

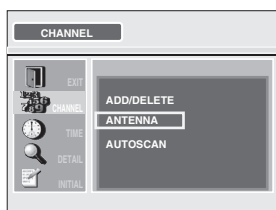

- STB starts receiving the signal for the channel.

- 5 By referring to the on-screen indication, adjust the antenna's direction to get the best reception.

### Status bar:

Stretches to the right as the signal strength gets stronger.

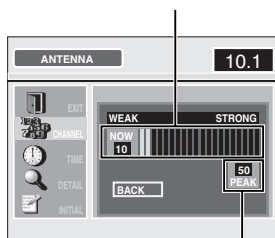

### Peak indicator:

Indicates the highest strength ever reached.

To adjust other channels:

Select the channel using [CH ▲ / ▼], then adjust it.

- 6 Press [SETUP] to exit.

## Selecting Display Mode

You can adjust the aspect ratio of the digital TV program to fit your 4:3 TV monitor.

### Display Mode

- 1 Press [SETUP].
- 2 Select "DETAIL" using [▲ / ▼], then press [OK].

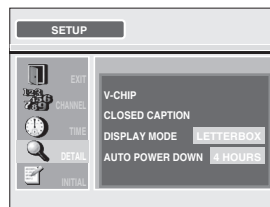

- 3 Select "DISPLAY MODE" using [▲ / ▼], then press [OK].

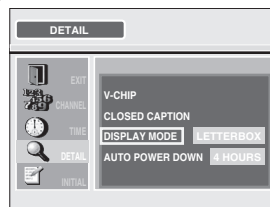

- 4 Select the desired display mode using [▲ / ▼], then press [OK].

\* Descriptions of each settings are explained in the "Information on Display Mode" on the next page.

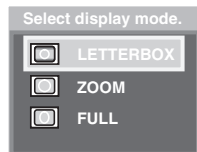

- 5 Press [SETUP] to exit.

## Information on Display Mode

### LETTERBOX



16:9 picture is scaled down until the both sides of the picture fits the 4:3 TV. Black bars appear on top and bottom of the TV screen.

### ZOOM



Displays the 16:9 image with the top and the bottom of the picture fit to the 4:3 TV screen. Both sides of the picture are cut off.

### FULL

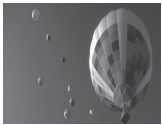

16:9 image is squeezed into the 4:3 TV screen. No parts are cropped, but the picture gets distorted.

### CAUTION:

If the TV is left in LETTER BOX mode for a long period of time, the black bars may cause a permanent burn-in effect.

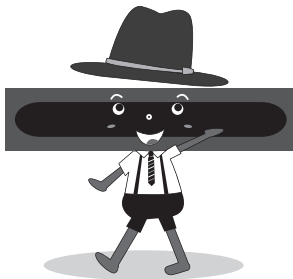

## Setting the Time Zone and D.S.T (Daylight Saving Time)

You need to select the time zone of your area and set D.S.T correctly to make use of the EPG and the Channel banner function.

- 1 Press [SETUP].
- 2 Select "TIME" using [▲/▼], then press [OK].

### Time Zone

- 3 Select "TIME ZONE" using [▲/▼], then press [OK].



- 4 Select your time zone using [▲/▼], then press [OK].

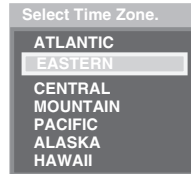

- 5 Press [SETUP] to exit.

# Advanced Operation

## D.S.T (Daylight Saving Time)

- 3 Select "D.S.T" using [▲ / ▼], then press [OK].



- 4 Select "ON" or "OFF" using [◀ / ▶], then press [OK].

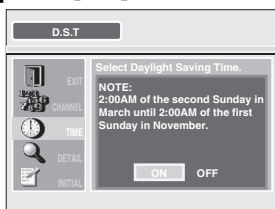

- 5 Press [SETUP] to exit.

## V-chip Options

V-chip reads the ratings for programs, then denies access to the programs which exceed the rating level you set. With this function, you can block certain programming inappropriate for children.

- 1 Press [SETUP].
- 2 Select "DETAIL" using [▲ / ▼], then press [OK].
- 3 Select "V-CHIP" using [▲ / ▼], then press [OK].

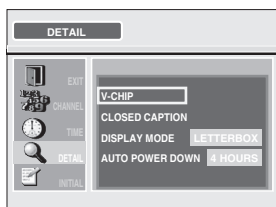

- Password entry field will appear.
- If you have not created a password yet...**  
- proceed to step 4-a.
- If you have already set a password...**  
- proceed to 4-b.
- If you want to change the password...**  
- proceed to "New Password" on page 24.

- 4-a Enter 4-digit numbers except 4737 as your password using [the Number buttons].

- Enter exactly the same password again in "Confirm password." entry field.

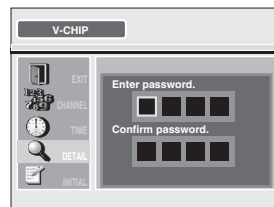

### CAUTION:

- Do not forget the password. It will be used as your V-chip access password from the next time onward.

- 4-b Enter the password using [the Number buttons].

- Asterisk(\*) will substitute for your password.



### NOTE:

- If you forget the password, enter "4737" then proceed to "New Password" on page 24.

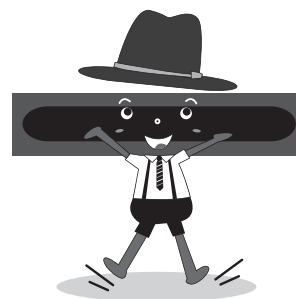

**5 Select the desired rating type using [▲ / ▼], then press [OK].**

E.g., "TV RATING"

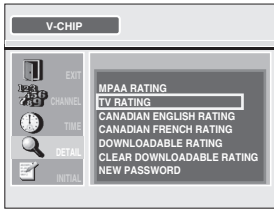

**NOTE:**

- "DOWNLOADABLE RATING" will be available when the STB receives a digital broadcast which contains V-chip 2.0 signal.
- If the broadcasting signal does not have the downloadable rating information, "Downloadable Rating is currently not available." will appear. This message will also appear when you try to access "DOWNLOADABLE RATING" after you have cleared the downloadable rating information, and the new information has not been downloaded since.
- To clear the downloadable rating information and its setting, select "CLEAR DOWNLOADABLE RATING".

**6 Select the desired rating using [▲ / ▼], then press [OK] repeatedly to switch between view and block.**

- When the rating is blocked, will appear.

E.g.,

"MPAA rating"

"TV rating"

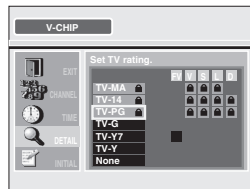
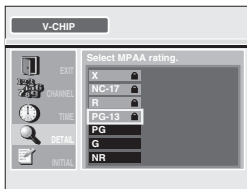

"Canadian English rating"

"Canadian French rating"

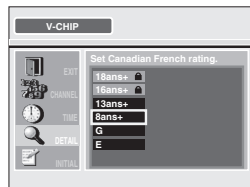
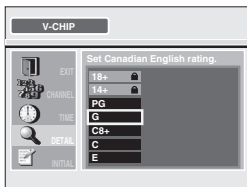

**MPAA Rating**

Rating	Description	
X	Mature audience only	higher
NC-17	No one under 17 admitted	↑
R	Restricted; under 17 requires accompanying parent or adult guardian	
PG-13	Unsuitable for children under 13	↓
PG	Parental guidance suggested	
G	General audience	lower
NR	No rating	

**TV Rating**

Rating	Description	
TV-MA	Mature audience only	higher
TV-14	Unsuitable for children under 14	↑
TV-PG	Parental guidance suggested	
TV-G	General audience	↓
TV-Y7	Appropriate for all children 7 and older	
TV-Y	Appropriate for all children	lower
None	No rating	

# Advanced Operation

## To Set the Sub Ratings for "TV RATING"

As for TV-MA, TV-14, TV-PG, or TV-Y7, you can further set the sub ratings to block specific elements of programming. To set the sub ratings, follow the step below.

Use [▲/▼/◀/▶] to select the desired rating or sub rating, then press [OK] repeatedly to switch between view and block. Sub rating status will appear beside the main rating.

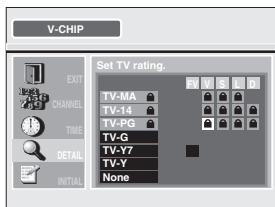

Sub Rating	Description
FV	Fantasy Violence
V	Violence
S	Sexual Situation
L	Coarse Language
D	Suggestive Dialogue

- Changing the main rating to block or view automatically changes all its sub ratings to the same (block or view).

## Canadian English Rating

Rating	Description	
18+	Adult audience only	higher ↑ ↓ lower
14+	Unsuitable for ages under 14	
PG	Parental guidance suggested	
G	General audience	
C8+	For children over 8	
C	For all children	
E	Exempt program	lower

## Canadian French Rating

Rating	Description	
18 ans+	Adult audience only	higher ↑ ↓ lower
16 ans +	Unsuitable for ages under 16	
13 ans +	Unsuitable for ages under 13	
8 ans +	Unsuitable for ages under 8	
G	General audience	
E	Exempt program	

## 7 Press [SETUP] to exit.

### NOTE:

- When you select a rating and set it to block, the higher ratings will be blocked automatically. The lower ratings will be available for viewing.
- When you set the highest rating to view, all ratings will turn to view automatically.

## New Password

When you forget the password or when you want to change your password, follow the instructions below.

- 1 Press [SETUP].
- 2 Select "DETAIL" using [▲/▼], then press [OK].
- 3 Select "V-CHIP" using [▲/▼], then press [OK].
- 4 Enter 4737 in the password entry field.
- 5 Select "NEW PASSWORD" using [▲/▼], then press [OK].

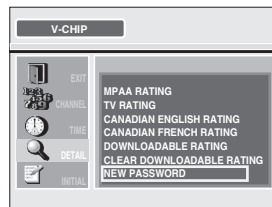

- 6 Enter the new 4-digit password using [the Number buttons].

- Enter exactly the same password again in "Confirm password." entry field.

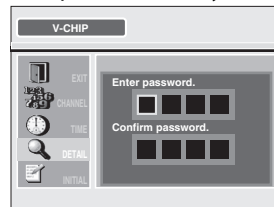

- 7 Press [SETUP] to exit.



## Closed Caption Options

DTV has its own closed caption called DTV CC. Use this menu to change the settings for DTV CC.

- 1 Press [SETUP].
- 2 Select "DETAIL" using [▲ / ▼], then press [OK].
- 3 Select "CLOSED CAPTION" using [▲ / ▼], then press [OK].

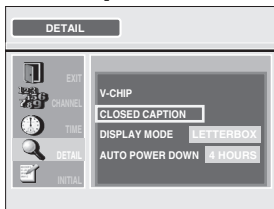

- 4 Select the desired closed caption item using [▲ / ▼], then press [OK].

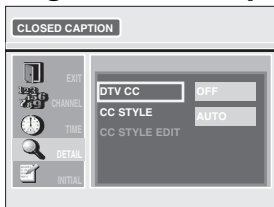

### DTV CC

Digital TV has its own closed captions called DTV CC. Use this menu to change the settings for DTV CC.

- 5 Select the desired DTV closed caption using [▲ / ▼], then press [OK].



DTV CC	Off	Select if you do not want DTV CC. This is the default.
	Service 1~6	Select one of these before changing any other item in "CLOSED CAPTION" menu. Choose "SERVICE1" under normal circumstances.

"DTV CC" differs depending on the broadcast.

### CC Style

You need to set "CC STYLE" to "MANUAL" to customize your CC style.

- 5 Select "MANUAL" using [▲ / ▼], then press [OK].



If you select "AUTO"...

- the original CC style set by the broadcast station will be applied.

If you select "MANUAL"...

- you can customize the CC style as you like.

### CC Style Edit

You can edit the style of CC such as font, color or size, etc. This feature is available only when "CC STYLE" is set to "MANUAL".

- 5 Select an item using [▲ / ▼], then press [OK]. Then use [▲ / ▼] to select the desired setting and press [OK].

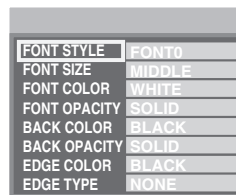

Picture display



Edge  
(Edge Color and Edge Type)

Font  
(Font Style, Font Size, Font Color and Font Opacity)

- 6 Press [SETUP] to exit.

# Advanced Operation / Others

## Auto Power Down

"Auto power down" shuts down the STB automatically after a certain period of time you set. (The EPA (U.S. Environmental Protection Agency) recommends using this setting to conserve energy.)

- 1 Press [SETUP].
- 2 Select "DETAIL" using [▲ / ▼], then press [OK].
- 3 Select "AUTO POWER DOWN" using [▲ / ▼], then press [OK].

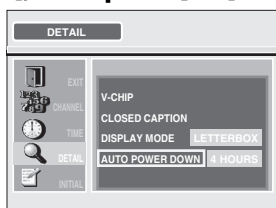

- 4 Select desired amount of time using [▲ / ▼], then press [OK].

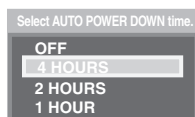

- Select "OFF" to cancel the auto power down.

- 5 Press [SETUP] to exit.

## Specifications

### Product

DTV Digital to Analog Converter

### Tuner

Receivable channels 2-69ch

### Connecting Jacks

#### ANT. IN/OUT

RF connector x2 (75ohm)

#### Video Output

RCA jack x1, 1Vpp (75ohm)

#### Analog Audio Output

RCA jack (L / R) x2

2V rms (100k ohm)

### Power Source

120V AC+/-10%, 60Hz+/-0.5%

### Power Consumption

8W (Power on), Less than 1 W (Power off)  
ENERGY STAR adopted.

### Closed Caption System

§15.122/FCC (digital CC)

### Operating Condition

41°F (5°C) - 104°F (40°C)

### Dimensions (W x H x D)

9.7" x 1.7" x 6"  
(244mm x 43mm x 150mm)

### Weight

1.4lbs. (0.6Kg)

Designs and Specifications are subject to change without notice.

## Troubleshooting

Before requesting service, check the table below for a possible cause of the problem.

Symptom	Remedy
<b>No power</b>	<ul style="list-style-type: none"> <li>• Make sure that the AC power cord is securely plugged into the power outlet.</li> <li>• Make sure that the STB's main power is on.</li> </ul>
<b>The STB is not responding to the remote control.</b>	<ul style="list-style-type: none"> <li>• Make sure to point the remote control at the remote control sensor.</li> <li>• You may be too far from STB. Try moving closer.</li> <li>• Remove any obstacles between the remote control and the remote control sensor.</li> <li>• Make sure that the batteries are installed in the correct direction (+ and -). ( ⇨ Page 7.)</li> <li>• The batteries may be depleted. Replace them with new ones.</li> </ul>
<b>No audio / picture</b>	<ul style="list-style-type: none"> <li>• Make sure that the audio / video cables are correctly connected.</li> <li>• Make sure that the TV is turned on.</li> <li>• Make sure that the correct viewing channel (ch3 or external input channel) is selected on your TV. ( ⇨ Page 13.) Refer to your TV's manual for further information.</li> <li>• Make sure the cables are not damaged.</li> </ul>
<b>Blocked noise on picture</b>	<ul style="list-style-type: none"> <li>• Make sure that the RF cable is connected correctly. ( ⇨ Pages 10 - 12.)</li> </ul>
<b>No EPG or the provided information is wrong</b>	<ul style="list-style-type: none"> <li>• Make sure that "D.S.T" and "TIME ZONE" is set correctly. ( ⇨ Page 21.)</li> </ul>
<b>Low volume</b>	<ul style="list-style-type: none"> <li>• Sound volume differs depending on the audio out setting. Select "RF OUT" at step 6 in the "Initial Setup (Setup Wizard)". ( ⇨ Page 14.)</li> </ul>
<b>No reception</b>	<ul style="list-style-type: none"> <li>• Make sure to complete autoscans in "SETUP WIZARD" or in "SETUP" menu. When autoscans are not completed, some channels will not be received.</li> <li>• The selected channel does not exist at that time. There are not always sub-channels being broadcast.</li> <li>• Some channels with weak signal may not be received properly. This is not a malfunction.</li> </ul>
<b>When you forget the password for V-chip</b>	<ul style="list-style-type: none"> <li>• If you forget the password, refer to "New Password". ( ⇨ Page 24.)</li> </ul>
<b>Closed captioning display (TEXT mode) does not go off even after changing channels through STB.</b>	<ul style="list-style-type: none"> <li>• Change the channel on your TV.</li> <li>• Turn the TV off, and then on.</li> </ul>
<b>The TV screen goes blank just after turning the STB on.</b>	<ul style="list-style-type: none"> <li>• This is a normal part of the start-up process and is not a malfunction.</li> </ul>



# MAGNAVOX

## LIMITED WARRANTY

FUNAI CORP. will repair this product, free of charge in the USA in the event of defect in materials or workmanship as follows:

### **DURATION:**

**PARTS:** FUNAI CORP. will provide parts to replace defective parts without charge for one (1) year from the date of original retail purchase. Certain parts are excluded from this warranty.

**LABOR:** FUNAI CORP. will provide the labor without charge for a period of ninety (90) days from the date of original retail purchase.

### **LIMITS AND EXCLUSIONS:**

THIS WARRANTY IS EXTENDED ONLY TO THE ORIGINAL RETAIL PURCHASER. A PURCHASE RECEIPT OR OTHER PROOF OF ORIGINAL RETAIL PURCHASE WILL BE REQUIRED TOGETHER WITH THE PRODUCT TO OBTAIN SERVICE UNDER THIS WARRANTY.

This warranty shall not be extended to any other person or transferee.

This warranty is void and of no effect if any serial numbers on the product are altered, replaced, defaced, missing or if service was attempted by an unauthorized service center. This limited warranty does not apply to any product not purchased and used in the United States.

This warranty only covers failures due to defects in material or workmanship which occur during normal use. It does not cover damage which occurs in shipment, or failures which are caused by repairs, alterations or products not supplied by FUNAI CORP., or damage, which results from accident, misuse, abuse, mishandling, misapplication, alteration, faulty installation, improper maintenance, commercial use such as hotel, rental or office use of this product, or damage which results from fire, flood, lightning or other acts of God.

THIS WARRANTY DOES NOT COVER PACKING MATERIALS, ANY ACCESSORIES (EXCEPT REMOTE CONTROL), ANY COSMETIC PARTS, COMPLETE ASSEMBLY PARTS, DEMO OR FLOOR MODELS.

FUNAI CORP. AND ITS REPRESENTATIVES OR AGENTS SHALL IN NO EVENT BE LIABLE FOR ANY GENERAL, INDIRECT OR CONSEQUENTIAL DAMAGES ARISING OUT OF OR OCCASIONED BY THE USE OF OR THE INABILITY TO USE THIS PRODUCT. THIS WARRANTY IS MADE IN LIEU OF ALL OTHER WARRANTIES, EXPRESS OR IMPLIED, AND OF ALL OTHER LIABILITIES ON THE PART OF FUNAI, ALL OTHER WARRANTIES INCLUDING THE WARRANTY OF MERCHANTABILITY AND FITNESS FOR A PARTICULAR PURPOSE, ARE HEREBY DISCLAIMED BY FUNAI AND ITS REPRESENTATIVES IN THE UNITED STATES.

ALL WARRANTY INSPECTIONS AND REPAIRS MUST BE PERFORMED BY AN AUTHORIZED SERVICE CENTER.

THIS WARRANTY IS ONLY VALID WHEN THE UNIT IS CARRIED-IN TO AN AUTHORIZED SERVICE CENTER.

THE PRODUCT MUST BE ACCOMPANIED BY A COPY OF THE ORIGINAL RETAIL PURCHASE RECEIPT. IF NO PROOF OF PURCHASE IS ATTACHED, THE WARRANTY WILL NOT BE HONORED AND REPAIR COSTS WILL BE CHARGED.

### **IMPORTANT:**

THIS LIMITED WARRANTY GIVES YOU SPECIFIC LEGAL RIGHTS. YOU MAY HAVE OTHER RIGHTS THAT VARY FROM STATE TO STATE. IF, AT ANY TIME DURING THE WARRANTY PERIOD, YOU ARE UNABLE TO OBTAIN SATISFACTION WITH THE REPAIR OF THIS PRODUCT, PLEASE CONTACT FUNAI CORP.

### **ATTENTION:**

FUNAI CORP. RESERVES THE RIGHT TO MODIFY ANY DESIGN OF THIS PRODUCT WITHOUT PRIOR NOTICE.

### **WARRANTY STATEMENT REGARDING NON AUTHORIZED REPAIRS:**

To obtain warranty service, you must take the product, or deliver the product freight prepaid, in either its original packaging or packaging affording an equal degree of protection, to any AUTHORIZED SERVICE CENTER. FUNAI CORP. will not reimburse you for any service done by unauthorized service providers without prior written approval.

**To locate your nearest AUTHORIZED SERVICE CENTER or for general service inquiries, please contact us at:**

**FUNAI SERVICE CORPORATION**

**Customer Service**

**Tel: 1-800-605-8610**

**<http://www.funai-corp.com>**

5653 Creekside Parkway, Suite A, Lockbourne, OH 43137