

COLOR ANALOG/DIGITAL TV WITH BUILT-IN VCR AND DVD PLAYER

27PC4326/37

User Manual



Thank you for choosing Philips.

Need help fast?

Read your Quick Start Guide and/or Owner's Manual first for quick tips that make using your Philips product more enjoyable.

If you have read your instructions and still need assistance, you may access our online help at

www.philips.com/usasupport
or call

1-888-PHILIPS (744-5477)

while with your product
(and Model / Serial number)



Philips vous remercie de
votre confiance.

Besoin d'une aide rapide?

Les Guide de mise en route rapide et Manuel de l'utilisateur regorgent d'astuces destinées à simplifier l'utilisation de votre produit Philips.

Toutefois, si vous ne parvenez pas à résoudre votre problème, vous pouvez accéder à notre aide en ligne à l'adresse

www.philips.com/usasupport
ou fomez le

1-800-661-6162 (Francophone)

1-888-PHILIPS (744-5477) (English speaking)

Veillez à avoir votre produit à
portée de main
(et model / serial nombre)



Gracias por escoger Philips.

Necesita ayuda inmediata?

Lea primero la Guía de inicio rápido o el Manual del usuario, en donde encontrará consejos que le ayudarán a disfrutar plenamente de su producto Philips.

Si después de leerlo aún necesita ayuda, consulte nuestro servicio de asistencia en línea en

www.philips.com/usasupport
o llame al teléfono

1-888-PHILIPS (744-5477)

y tenga a mano el producto
(y número de model / serial)



27PC4326

PHILIPS

Return your Product Registration Card or register online at www.philips.com/usasupport today to get the very most from your purchase.

Registering your model with PHILIPS makes you eligible for all of the valuable benefits listed below, so don't miss out. Complete and return your Product Registration Card at once, **or register online at www.philips.com/usasupport** to ensure:

***Proof of Purchase**

Returning the enclosed card guarantees that your date of purchase will be on file, so no additional paperwork will be required from you to obtain warranty service.

***Product Safety Notification**

By registering your product, you'll receive notification - directly from the manufacturer - in the rare case of a product recall or safety defect.

***Additional Benefits**

Registering your product guarantees that you'll receive all of the privileges to which you're entitled, including special money-saving offers.

PHILIPS

Congratulations on your purchase, and welcome to the "family!"

Dear PHILIPS product owner:

Thank you for your confidence in PHILIPS. You've selected one of the best-built, best-backed products available today. We'll do everything in our power to keep you happy with your purchase for many years to come.

As a member of the PHILIPS "family," you're entitled to protection by one of the most comprehensive warranties and outstanding service networks in the industry. What's more, your purchase guarantees you'll receive all the information and special offers for which you qualify, plus easy access to accessories from our convenient home shopping network.



Most importantly, you can count on our uncompromising commitment to your total satisfaction.

All of this is our way of saying welcome - and thanks for investing in a PHILIPS product.

P.S. To get the most from your PHILIPS purchase, be sure to complete and return your Product Registration Card at once, or register online at:

www.philips.com/usasupport

Know these **safety** symbols

	CAUTION RISK OF ELECTRIC SHOCK DO NOT OPEN	
CAUTION: TO REDUCE THE RISK OF ELECTRIC SHOCK, DO NOT REMOVE COVER (OR BACK). NO USER-SERVICEABLE PARTS INSIDE. REFER SERVICING TO QUALIFIED SERVICE PERSONNEL.		



This "bolt of lightning" indicates uninsulated material within your unit may cause an electrical shock. For the safety of everyone in your household, please do not remove product covering.



The "exclamation point" calls attention to features for which you should read the enclosed literature closely to prevent operating and maintenance problems.

WARNING: To reduce the risk of fire or electric shock, this apparatus should not be exposed to rain or moisture, and objects filled with liquids, such as vases, should not be placed on this apparatus.

CAUTION: To prevent electric shock, match wide blade of plug to wide slot, fully insert.

ATTENTION: Pour éviter les choc électriques, introduire la lame la plus large de la fiche dans la borne correspondante de la prise et pousser jusqu'au fond.

For Customer Use

Enter below the Serial No. which is located on the rear of the cabinet. Retain this information for future reference.

Model No. _____
Serial No. _____

PHILIPS Visit our World Wide Web Site at <http://www.philips.com/usasupport>

Safety and General Information 3

IMPORTANT SAFETY INSTRUCTIONS

Read before operating equipment

1. Read these instructions.
2. Keep these instructions.
3. Heed all warnings.
4. Follow all instructions.
5. Do not use this apparatus near water.
6. Clean only with a dry cloth.
7. Do not block any of the ventilation openings. Install in accordance with the manufacturers instructions.
8. Do not install near any heat sources such as radiators, heat registers, stoves, or other apparatus (including amplifiers) that produce heat.
9. Do not defeat the safety purpose of the polarized or groundingtype plug. A polarized plug has two blades with one wider than the other. A grounding type plug has two blades and third grounding prong. The wide blade or third prong are provided for your safety. When the provided plug does not fit into your outlet, consult an electrician for replacement of the obsolete outlet.
10. Protect the power cord from being walked on or pinched particularly at plugs, convenience receptacles, and the point where they exit from the apparatus.
11. Only use attachments/accessories specified by the manufacturer.
12.  Use only with a cart, stand, tripod, bracket, or table specified by the manufacturer, or sold with the apparatus. When a cart is used, use caution when moving the cart/apparatus combination to avoid injury from tip-over.
13. Unplug this apparatus during lightning storms or when unused for long periods of time.
14. Refer all servicing to qualified service personnel. Servicing is required when the apparatus has been damaged in any way, such as power-supply cord or plug is damaged, liquid has been spilled or objects have fallen into apparatus, the apparatus has been exposed to rain or moisture, does not operate normally, or has been dropped.
15. This product may contain lead and mercury. Disposal of these materials may be regulated due to environmental considerations. For disposal or recycling information, please contact your local authorities or the Electronic Industries Alliance: www.eiae.org
16. **Damage Requiring Service** - The appliance should be serviced by qualified service personnel when:
 - A. The power supply cord or the plug has been damaged; or
 - B. Objects have fallen, or liquid has been spilled into the appliance; or
 - C. The appliance has been exposed to rain; or
 - D. The appliance does not appear to operate normally or exhibits a marked change in performance; or
 - E. The appliance has been dropped, or the enclosure damaged.
17. **Tilt/Stability** - All televisions must comply with recommended international global safety standards for tilt and stability properties of its cabinet design.
 - Do not compromise these design standards by applying excessive pull force to the front, or top, of the cabinet which could ultimately overturn the product.
 - Also, do not endanger yourself, or children, by placing electronic equipment/toys on the top of the cabinet. Such items could unsuspectingly fall from the top of the set and cause product damage and/or personal injury.
18. **Wall or Ceiling Mounting** - The appliance should be mounted to a wall or ceiling only as recommended by the manufacturer.
19. **Power Lines** - An outdoor antenna should be located away from power lines.
20. **OutdoorAntenna Grounding** - If an outside antenna is connected to the receiver, be sure the antenna system is grounded so as to provide some protection against voltage surges and built up static charges. Section 810 of the National Electric Code, ANSI/NFPA No. 70- 1984, provides information with respect to proper grounding of the mast and supporting structure, grounding of the lead-in wire to an antenna discharge unit, size of grounding connectors, location of antenna-discharge unit, connection to grounding electrodes, and requirements for the grounding electrode. See Figure below.
21. **Object and Liquid Entry** - Care should be taken so that objects do not fall and liquids are not spilled into the enclosure through openings.
 - a) **Warning:** To reduce the risk of fire or electric shock, this apparatus should not be exposed to rain or moisture and objects filled with liquids, such as vases, should not be placed on this apparatus.
22. **Battery Usage CAUTION** - To prevent battery leakage that may result in bodily injury, property damage, or damage to the unit:
 - Install all batteries correctly, with + and - aligned as marked on the unit.
 - Do not mix batteries (old and new or carbon and alkaline, etc.).
 - Remove batteries when the unit is not used for a long time.
23. **Overloading** - Do not overload wall outlets, extension cords, or integral convenience receptacles as this can result in a risk of fire or electric shock.
24. **Object and Liquid Entry** - Never push objects of any kind into this product through openings as they may touch dangerous voltage points or short-out parts that could result in a fire or electric shock. Never spill liquid of any kind on the product.
25. **Replacement Parts** - When replacement parts are required, be sure the service technician has used replacement parts specified by the manufacturer or have the same characteristics as the original part. Unauthorized substitutions may result in fire, electric shock, or other hazards.
26. **Safety Check** - Upon completion of any service or repairs to this product, ask the service technician to perform safety checks to determine that the product is in proper operating condition.

Note to the CATV system installer: This reminder is provided to call the CATV system installer's attention to Article 820-40 of the NEC that provides guidelines for proper grounding and, in particular, specifies that the cable ground shall be connected to the grounding system of the building, as close to the point of cable entry as practical.

Example of Antenna Grounding as per NEC - National Electric Code

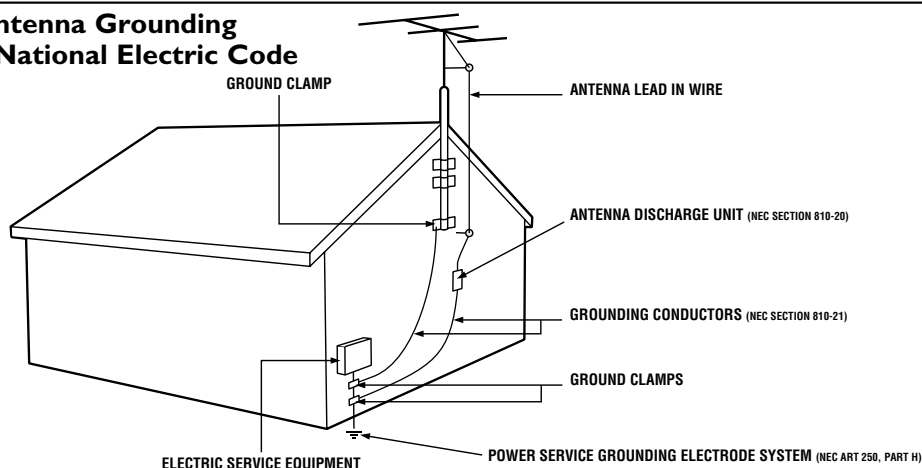

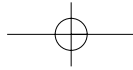

4 Safety and General Information (cont'd)

Safety Precautions

- Do not stand the unit up vertically. Install the unit in a horizontal and stable position.
- Be sure to remove the disc and unplug the AC power cord from the outlet before carrying the unit.

Warning: To prevent fire or shock hazard, do not expose this equipment to rain or moisture.

Federal Communications Commission (FCC) Warning: Any unauthorized changes or modifications to this equipment void the user's authority to operate it.

Laser Safety: This unit employs a laser. Only a qualified service person should remove the cover or attempt to service this device, due to possible eye injury.

CAUTION: USE OF CONTROLS OR ADJUSTMENTS OR PERFORMANCE OF PROCEDURES OTHER THAN THOSE SPECIFIED HEREIN MAY RESULT IN HAZARDOUS RADIATION EXPOSURE.
CAUTION: VISIBLE AND INVISIBLE LASER RADIATION WHEN OPEN AND INTERLOCK DEFEATED. DO NOT STARE INTO BEAM. THE BEAM IS LOCATED INSIDE, NEAR THE DECK MECHANISM.

Special Information for Canadian Users: This Class B digital apparatus complies with Canadian ICES-003. Cet appareil numérique de la classe B est conforme à la norme NMB-003 du Canada.

Radio/TV Interference: This equipment has been tested and found to comply with the limits for a Class B digital device, pursuant to Part 15 of the FCC Rules. These limits are designed to provide reasonable protection against harmful interference in a residential installation. This equipment generates, uses, and can radiate radio frequency energy and, if not installed and used in accordance with the instructions, may cause harmful interference to radio communications. However, there is no guarantee that interference will not occur in a particular installation. If this equipment does cause harmful interference to radio or television reception, which can be determined by turning the equipment off and on, the user is encouraged to try to correct the interference by one or more of the following measures:

- 1) Reorient or relocate the receiving antenna.
- 2) Increase the separation between the equipment and the receiver.
- 3) Connect the equipment into an outlet on a circuit different from that to which the receiver is connected.
- 4) Consult the dealer or an experienced radio/TV technician for help.

Copyright Notice: The making of unauthorized copies of copy-protected material, including computer programs, files, broadcasts and sound recordings, may be an infringement of copyrights and constitute a criminal offence. This equipment should not be used for such purposes.

Copyright Protection: Unauthorized copying, broadcasting, public performance and lending of discs are prohibited. "This product incorporates copyright protection technology that is protected by U. S. patents and other intellectual property rights. Use of this copyright protection technology must be authorized by Macrovision, and is intended for home and other limited viewing uses only unless otherwise authorized by Macrovision. Reverse engineering or disassembly is prohibited."

Declaration of Conformity

Model Number: 27PC4326/37
Trade Name: Philips
Responsible Party: Philips Consumer Electronics North America
P.O. Box 671539
Marietta, GA 30006-0026
1-888-PHILIPS (744-5477)

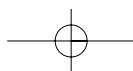

Table of Contents 5

General Information

Safety and General Information3-4
 Table of Contents5
 Introduction6
 Playable Discs and Videotapes7

Initial Setup and Use

Before Using the TV/VCR/DVD8
 Hooking Up the TV/VCR/DVD9-10
 Optional Connections11
 Remote Control Buttons12-13
 Front Panel14
 Rear Panel15
 Watching TV16
 Playing a Videotape17
 Playing a Disc18

TV Settings

Menu Language, Auto Channel Preset19
 Adding/Deleting Channels20
 Setting the Clock21-24
 Daylight-Savings Time25
 Time Zone26
 Status Displays27-28
 Picture Controls28

Recording

Videotape Recording29
 One-Touch Recording30
 Timer Recording31-34
 Timer Recording Auto Return35
 Rerecording (Tape Duplication)36

Videotape Features

Repeat Playback37
 Rental Playback38
 Zero Return, Sleep Timer39
 Time Search40
 Index Search41
 Videotape Playback Features42
 Automatic Operation Features43

Additional TV Features

Closed Captions (TV)44
 Closed Captions (DTV)45-47
 Setting V-Chip48-53
 Changing the Screen Display Mode (DTV) ..54
 Multi-Channel Television Sound (MTS) ...55-57

Disc Features

DVD Disc Menus, Title Menus58
 Fast Forward/Fast Reverse59
 Chapter/Title/Time Search60
 Track Search61
 Paused and Step-by-Step Playback, Resume On ...62
 Repeat, A-B Repeat63
 Markers64
 Subtitles, Camera Angles65
 Audio Language, Stereo Sound66
 Slow Motion, Zoom67
 Random Playback, Program Playback68
 MP3/Windows Media™ Audio/JPEG Playback ...69
 Dual Playback, Folder Playback70
 On-Screen Displays71-72
 Black Level, Virtual Surround, Initializing73

DVD Setup Features

Language Settings74-75
 Display Settings76-77
 Audio Settings78
 Parental Settings79-81
 Others82-83

Information You May Need

Glossary84
 Helpful Hints85-86
 Specifications87
 Limited Warranty88
 Index89

Symbols Used in This Manual

The following symbols appear in some headings and notes in this manual.



Description refers to playback of DVDs.



Description refers to playback of Video CDs.



Description refers to playback of Video CDs without PBC function.



Description refers to playback of Audio CDs.



Description refers to playback of MP3 discs.



Description refers to playback of Windows Media™ Audio CDs.



Description refers to playback of JPEG discs.

TV/VCR/DVD

DVD

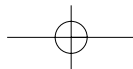

6 Introduction

Welcome to your TV/VCR/DVD Owner's Manual.

Features - TV/VCR

- Automatic Channel Setup
- Automatic Head Cleaner
- Automatic Tracking Adjustment
- Closed Captions
- Daylight-Savings Time
- English, Spanish or French Setup menus
- Forward/Reverse Searching; Still
- High Quality (HQ) System
- Index Search
- One-Touch Recording
- Real-Time Videotape Counter
- Rental Playback
- Repeat Playback
- Sleep Timer
- Timer Recording
- Time Search
- Time Zone Setting
- V-Chip (Parental Controls)
- Zero Return

Features - Discs

- Audio Language choices *
 - Bit Rate Display
 - Camera Angle *
 - Dolby Digital Sound *
 - Dual Playback
 - Dynamic Range Control
 - Fast/Paused/Slow/Step-by-Step Playback
 - JPEG Playback
 - Markers
 - MP3/Windows Media™ Audio Playback
 - Parental Controls *
 - Program Playback
 - Random Playback
 - Repeat (A-B, Chapter, Title, Track, Group, Disc)
 - Search (Title/Chapter, Time, Track)
 - Subtitles *
 - Virtual Surround
 - Zoom
- * If available on the disc

Package Contents

- Remote Control
- Two AAA batteries
- User Manual
- Quick Start Guide
- Registration Card

DVD Disc Menus...

Some explanations in this manual describe DVD Disc menus. DVD manufacturers set the menus, which vary among DVDs. Not all DVDs have menus. If the DVD has a menu, access it by pressing DISC MENU on the remote control.

Details are on page 58.

Setup Menus...

Some instructions explain how to use the Setup menus of the TV/VCR/DVD. There are two Setup menus: one for the TV/VCR features while the unit is in TV/VCR mode, and one for the disc features while the unit is in DVD mode. Access the Setup menus by pressing SET-UP on the remote control.

While in TV/VCR mode, you can select only the MAIN MENU.

In DVD mode, you can select both the MAIN MENU and the SETUP menu for the unit's DVD player. Press SET-UP once to select the MAIN MENU. Press SET-UP twice to get to the DVD player's SETUP menu.

Even if you set a DVD feature in the unit's SETUP menu, it will not be available if the current disc does not include that feature.

Available Disc Features...



All features described in this manual are not available on every disc. If the feature is not available on the disc, you cannot use the TV/VCR/DVD to make it available.

An "X" will appear in the top right corner of the screen if you try to access a feature that is not available.

For example, some features are available only during playback, while others are available only if playback is stopped. If you cannot access a feature, try stopping or starting playback, then try the feature again.

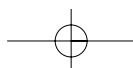

Playable Discs and Videotapes 7

Playable Discs

The DVD player of this TV/VCR/DVD will play many types of discs, including Digital Video Discs (DVDs) and Audio Compact Discs (CDs). It will play MP3, Windows Media™ Audio and JPEG files as well.

To play a DVD, make sure it meets the requirements for Region Codes and Color Systems as described below. Discs that have the following logos will play on the DVD player of this TV/VCR/DVD. Finalize CD-R, CD-RW, DVD+R and DVD+RW Discs before playing them in the TV/VCR/DVD.

- A disc may not play properly if the disc's recorded area is less than 55mm across.
- Do not glue paper or put stickers on to the disc. These may damage the disc, and the TV/VCR/DVD may not read it correctly.



DVD: Prerecorded Digital Video Discs



Video CDs



CD-RW: Compact Disc Rewritable.

CD-RWs can be recorded on multiple times.



DVD+R: DVD Recordable. DVD+Rs can be recorded on only once.



Audio CDs



DVD+RW: DVD Rewritable. DVD+RWs can be recorded on multiple times.



CD-R: Compact Disc Recordable. CD-Rs can be recorded on only once.



MP3: Digital audio files recorded on a CD-R or CD-RW



DVD is a trademark of DVD Format/Logo Licensing Corporation.

Windows Media is a trademark of Microsoft Corporation.

This unit is not compatible with Multiple Bit Rate

(MBR: a file that contains the same content encoded at several different bit rates).

ABOUT THE PBC FUNCTION OF VIDEO CD

This unit can play Video CD 1.1 (without PBC) and 2.0 (with PBC).

With version 2.0 (with PBC), you can use interactive menu (e.g., playlists) on the TV screen.

When playing a Video CD with PBC, some operations cannot be performed unless the PBC function is cancelled temporarily. See page 58 for more details.

Region Codes

This TV/VCR/DVD has a Region One (1) DVD player. DVDs must be labeled for ALL regions or for Region 1 in order to play on the unit. You cannot play DVDs that are labeled for other regions. Look for the symbols below on your DVDs. If these region symbols do not appear on your DVD, you cannot play the DVD in this TV/VCR/DVD.



The number inside the globe refers to a region of the world. Region 1 represents the United States, Canada, upper regions of North America, Bermuda, the U.S. Virgin Islands, and small regions near Australia.

A DVD labelled for a specific region can only play on DVD players with the same region code.

Color Systems

DVDs are recorded in different color systems throughout the world. The most common color systems are NTSC (which is used primarily in the United States and North America), PAL, and SECAM.

The DVD player of this unit uses NTSC, so DVDs you play must be recorded in the NTSC color system. You cannot play DVDs recorded in other formats. The color system of the DVD may be listed on the DVD or on the disc case.

Unacceptable Discs

If you insert an unacceptable type of disc, a Disc Error message may appear on the TV screen. The following discs will not play on this DVD player.

- CD-ROM
- Compact Disc-Interactive (CD-I)
- Unfinalized discs
- DVD-R or DVD-RW discs recorded in VR format or non-compatible recording mode
- DVD-RAM
- Video Single Disc (VSD)
- DVD contains MP3, Windows Media™ Audio or JPEG files
- DVD-ROM
- DVD-Audio

On the following disc, the sound may not be heard.

- Super Audio CD - Only the sound on the CD layer can be heard. The sound on the high-density Super Audio CD layer cannot be heard.

Videotapes

Philips recommends you use only videotapes that have the **VHS** mark. Other videotapes may have poor picture quality and cause excessive deposits on the video heads. The warranty may not cover such damage. The VCR of this TV/VCR/DVD has a High Quality (HQ) system and is compatible with existing Video Home System (VHS) equipment.

8 Before Using the TV/VCR/DVD

Remote Control Battery Installation

- 1** Remove the battery compartment lid on the bottom of the remote control. Slide the lid down and off. Follow the direction of the arrow on the lid.
- 2** Place two AAA batteries inside the battery compartment. Align the + and – ends as indicated.
- 3** Replace the battery compartment lid.

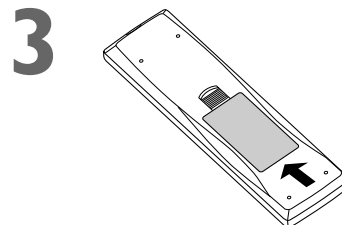
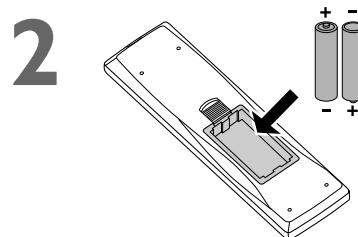
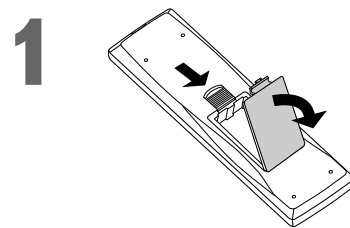

Battery Safety

Battery Usage CAUTION - To prevent battery leakage that may result in bodily injury, property damage or damage to the unit.

- Install ALL batteries correctly, with the + and – markings on the battery aligned as indicated on the unit.
- Do not mix batteries, for example, old with new or carbon with alkaline.
- Remove batteries when the unit will not be used for a long time.

Recording Prevention

Videotapes have record tabs to ensure you do not erase recordings accidentally.

- 1** To prevent accidental recording, break off the tab with a screwdriver.
- 2** To record again, cover the hole with cellophane tape.

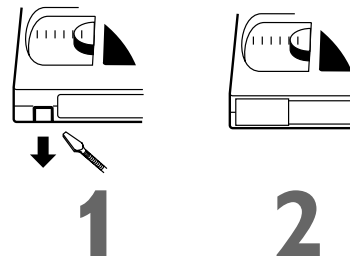

Using the Remote Control

- Point the remote control at the remote sensor on the front of the TV/VCR/DVD. *Details are on page 14.*
- Do not put objects between the remote control and the TV/VCR/DVD.

TV/VCR/DVD Maintenance

- Remove any light adhesive stick-on notes from the video cassette before putting the cassette in the TV/VCR/DVD. Removable labels can jam the TV/VCR/DVD.
- The TV/VCR/DVD requires periodic maintenance to maintain its excellent performance. This TV/VCR/DVD has an internal head cleaning system. However, the video heads will eventually require cleaning or replacement. Only an authorized service center should perform this service.

Helpful Hint

- Your new product, its packaging and this manual contain materials that can be recycled and reused. Specialized companies can recycle your product to increase the amount of reusable materials and to minimize the amount that needs to be properly disposed. Your product uses batteries that should not be thrown away when depleted but should be disposed of as small chemical waste. Please find out about the local regulations on disposal of your old product, batteries, manual and packaging when you replace existing equipment.

Hooking Up the TV/VCR/DVD 9

1 Hook up your TV/VCR/DVD using one of the connections shown.

A Hooking Up Your TV/VCR/DVD with a Cable TV Signal or Outdoor Antenna

Connect a Cable TV signal or an antenna to the ANT.(enna) Jack.

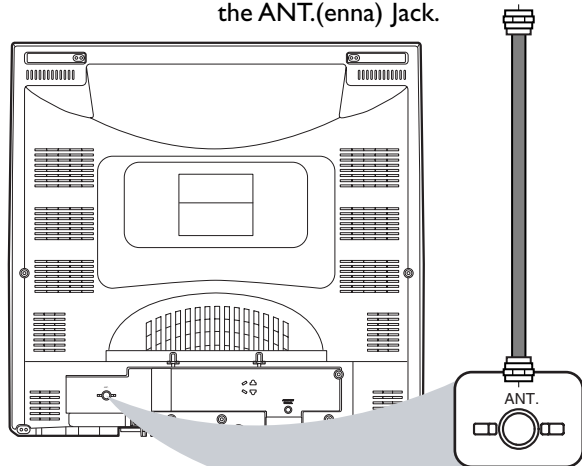

B Hooking Up Your TV/VCR/DVD with a Cable Box/Satellite Receiver

To view any channel, set the TV/VCR/DVD to the output channel (channel 03 or 04) of the Cable Box/Satellite Receiver. Then, select channels at the Cable Box/Satellite Receiver.

Connect the Cable TV or Satellite signal to the IN Jack on the Cable Box/Satellite Receiver.

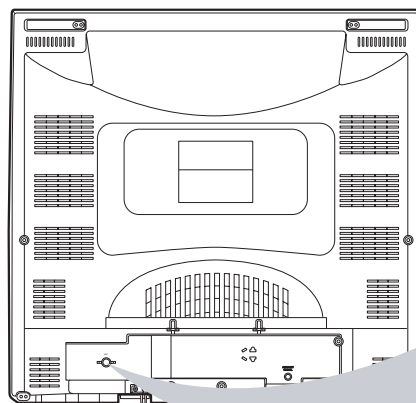

Connect an RF coaxial cable (not supplied) to the OUT Jack on the Cable Box/Satellite Receiver and to the ANT.(enna) Jack on the TV/VCR/DVD.

Your Cable Box/Satellite Receiver may have Audio and Video Out jacks instead of the single Antenna Out jack (RF coaxial or 75 ohm) shown here. If so, connect Audio and Video cables to the Audio/Video Out jacks of the Cable Box/Satellite Receiver and to the AUDIO/VIDEO In jacks on the front of the TV/VCR/DVD. Press SELECT on the remote to set the TV/VCR/DVD to AUX, not channel 3 or 4. Select channels you want to watch or record at the Cable Box/Satellite Receiver as usual, leaving the TV/VCR/DVD on AUX.

Instructions continue on the next page.

10 Hooking Up the TV/VCR/DVD (cont'd)

Instructions continued from the previous page.

C Hooking Up Your TV/VCR/DVD with an Indoor Antenna

To install an indoor antenna or "rabbit ears" (not supplied), connect the antenna wire to the ANT.(enna) Jack on the back of the TV/VCR/DVD as shown. Extend the antenna and adjust its length, direction and angle for the clearest picture.

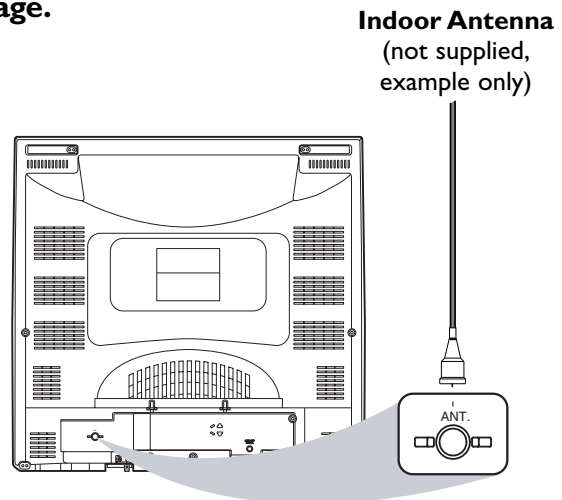

D Hooking Up Your TV/VCR/DVD to Another Video Source (VCR, DVD player, Camcorder, etc.)

You may need this connection if you want to play discs or tapes on other equipment but watch them on the TV/VCR/DVD. Press SELECT on the remote to select AUX at the TV/VCR/DVD. When you play the materials on the other equipment, it will show on the TV/VCR/DVD's AUX channel. *More details are on page 36.*

Audio and video cables are not supplied.

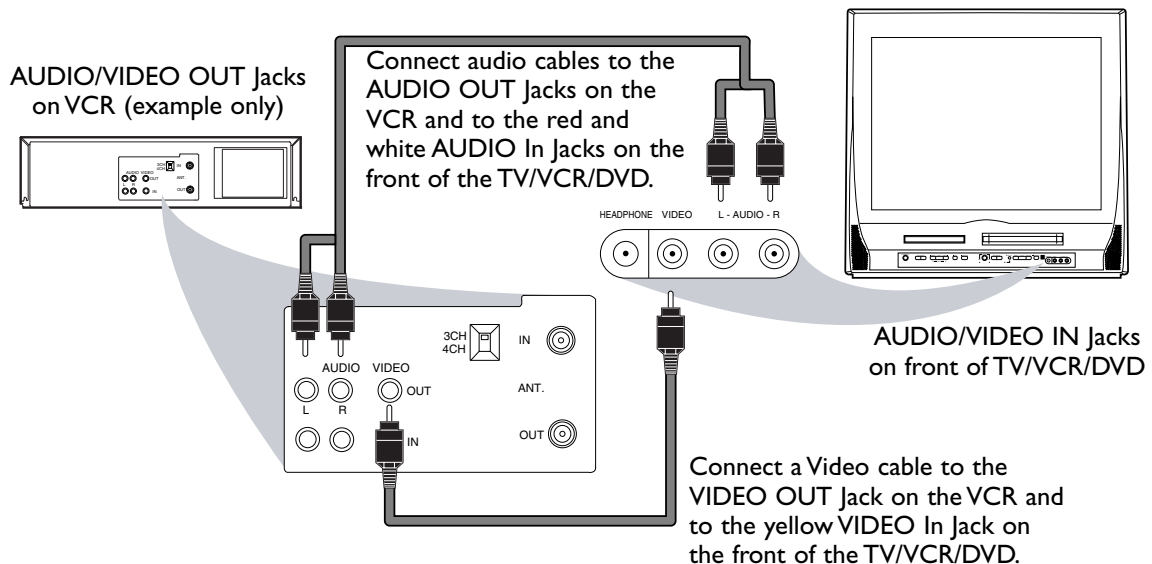

2 When all other connections are complete, plug in the TV/VCR/DVD's power cord.

Optional Connections 11

Digital Stereo Hookups

You can connect the TV/VCR/DVD to a Stereo that has a Digital Coaxial In jack. Use this hookup if you want to hear the TV/VCR/DVD sound through the Stereo instead. Use these connections for a Dolby Digital-compatible Stereo or for a Receiver that has a Mini-Disc or Digital Audio Tape deck.

- 1** Connect the antenna/Cable TV signal. Details are on pages 9-10.
- 2** Connect a digital audio coaxial cable (not supplied) to the **AUDIO OUT COAXIAL** jack on the TV/VCR/DVD. Also connect the cable to the Stereo's **COAXIAL DIGITAL AUDIO IN** jack.
- 3** If the Stereo is Dolby Digital-compatible, set **DOLBY DIGITAL** to **BITSTREAM**. If the Stereo is not Dolby Digital-compatible or if you connected to a Mini-Disc or Digital Audio Tape Deck, set **DOLBY DIGITAL** to **PCM**. Details are on page 78. An incorrect setting causes noise distortion and damages speakers.

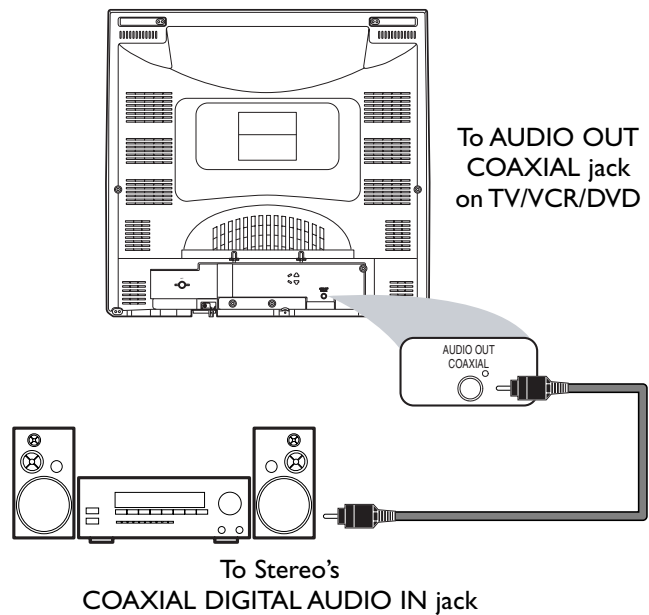

Helpful Hints

- You cannot use a Mini-Disc or Digital Audio Tape deck to copy Dolby Digital Multi-channel surround sound discs.
- If the disc is not recorded in Dolby Digital Multi-channel surround sound, you will not hear multi-channel sound even if you use the Digital Stereo hookup.
- To see if your disc is recorded in Dolby Digital, look for a Dolby Digital logo on disc or on its case.
- To see if your Stereo has Dolby Digital, look for a Dolby Digital logo on your Stereo. Or, refer to the Stereo owner's manual.

12 Remote Control Buttons

STANDBY-ON Button

Press to turn on or off the TV/VCR/DVD.

REC MODE Button

Press to choose a tape recording speed (SP or SLP).
Details are on page 29.

PLAY Button

Press to start playing a disc or video cassette. *Details are on pages 17-18.*

STOP Button

Press to stop disc or videotape playback.

Arrow Buttons

Use the Arrow buttons to select or adjust menu items.

DISC MENU Button

Press to access DVD Disc menus. *Details are on page 58.*

PICTURE/SLEEP Button

Press to set the Sleep Timer. *Details are on page 39.*

Press to access the picture controls. *Details are on page 28.*

SELECT Button

Press to select TV/VCR or DVD mode. (TV/VCR mode includes Analog TV, Digital TV or AUX mode.) The corresponding light (VCR/TV or DVD) will appear on the front of the TV/VCR/DVD to indicate which mode is active. *Details are on page 14.* To put the unit into the VCR mode, press PLAY  (VCR) when in any mode other than DVD. When the TV/VCR/DVD switches from analog to digital, it may take a while until the digital channel selection is completed.

OPEN/CLOSE Button

Press to open or close the disc tray. *Details are on page 18.*

REC Button

Press once to start a recording on videotape. *Details are on page 29.*

PAUSE Button

Press to pause videotape recording. Press again to resume recording. *Details are on page 29.*

Press to pause videotape or DVD playback. Press repeatedly to advance the picture one frame at a time. *Details are on pages 42 and 62.*

VOL. (volume) Buttons

Press to adjust the volume.

CH. (channel) Buttons

Press to select memorized TV channels. *Details are on page 16.*

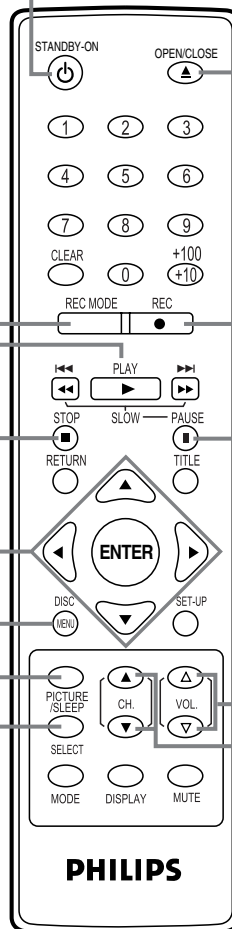

Remote Control Buttons (cont'd) 13

CLEAR Button

Press to reset or erase a setting or wrong information.
In TV mode, press once to display the tape counter. Press it twice to reset the counter to 0:00:00.
Details are on page 39.
Press to cancel a Timer Recording.
Details are on page 34.

◀◀/◀◀ Button

During disc playback;
- Press briefly to skip to the beginning of the current track/chapter.
- Press repeatedly to skip to previous tracks/chapters.
Details are on page 61.
- Press and hold for a few seconds to search backward.
Details are on page 59.
- Use this button in combination with PAUSE ■■ to start the Slow Motion Playback.
Details are on page 42 for videotape playback, and on page 67 for disc playback.
- Press to reverse a videotape.
Details are on page 42.

RETURN Button

Press to go to the previous Setup menu. Press to remove On-Screen Displays.

MODE Button

Press to access the settings listed below:

- Audio setting
Details are on pages 56-57 and 66.
- Search setting
Details are on pages 60 and 61.
- Repeat setting
Details are on page 63.
- A-B Repeat setting
Details are on page 63.
- Subtitle setting
Details are on page 65.
- Camera Angle setting
Details are on page 65.
- Zoom setting
Details are on page 67.
- Black Level setting
Details are on page 73.
- Virtual Surround setting
Details are on page 73.
- Random Playback setting
Details are on page 68.
- Program Playback setting
Details are on page 68.
- Folder playback setting.
Details are on page 70.

• Some settings are not available in specific modes.

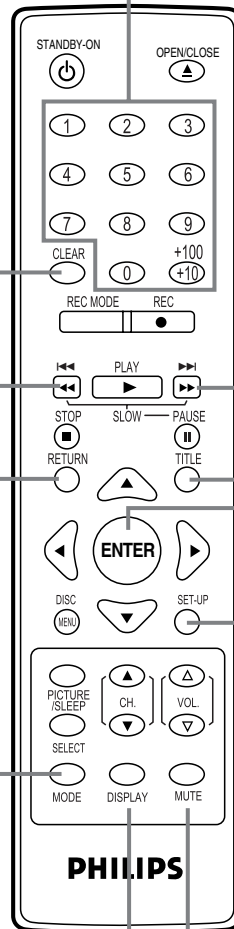

Number Buttons

TV/VCR Mode: Press two digits to access a specific channel. Press 0 before the number of a single-digit channel. *Details are on page 16.*
+100/+10 button: To select channels 100 or higher, press +100/+10, then the Number buttons of the last 2 digits of the channel number.
DTV Mode: Press to select the major or the minor channel.
DVD Mode: Use the Number buttons to enter a track or chapter number.
+100/+10 button: Press before entering double-digit numbers. For example, to select chapter 16, press +100/+10, then 1, 6.

▶▶/▶▶ Button

During disc playback;
- Press briefly to skip to the next track or chapter.
Details are on page 61.
- Press and hold for 2 seconds to search forward.
Details are on page 59.
- Use this button in combination with PAUSE ■■ to start the Slow Motion Playback.
Details are on page 42 for videotape playback, and on page 67 for disc playback.
- Press to forward the videotape.
Details are on page 42.

TITLE Button

Press to access a DVD's Title menu if available. *Details are on page 58.*

ENTER Button

Press to accept or change a menu setting.

SET-UP Button

Press to access or remove the TV/VCR/DVD's Setup menu.

MUTE Button

Press to mute or restore the sound.

DISPLAY Button

TV/VCR Mode: Press to see the videotape counter, channel or time on the screen. *Details are on page 27.*
DTV Mode: Press to display channel information. *Details are on pages 27-28.*
DVD Mode: Press to see the disc status on the screen. *Details are on page 71.*

14 Front Panel

Front design varies slightly among models.

Cassette Compartment

Insert a videotape here.

Disc Tray

Insert a disc here.

CHANNEL ▲/▼ Buttons

Press to select TV channels.

Details are on page 16.

OPEN/CLOSE ▲ Button (DVD)

Press to open or close the disc tray.

Details are on page 18.

STOP ■ Button (DVD)

Press to stop disc playback.

Details are on page 18.

PLAY ► Button (DVD)

Press to start disc playback.

Details are on page 18.

STANDBY-ON ⏻ Button

Press to turn the TV/VCR/DVD on or off. Turn off the TV/VCR/DVD for a timer recording.

VOLUME ▲/▼ Buttons

Press to adjust the volume.

PREV ◀◀, NEXT ▶▶ Buttons (DVD)

Press to go to a different chapter or track.

Details are on page 61.

DVD light (green)

Appears if the TV/VCR/DVD is in DVD mode.

SOURCE Button

Press to select TV/VCR or DVD mode. (TV/VCR mode includes Analog TV, Digital TV or AUX mode.) If you switch to TV/VCR mode, wait about 4 seconds before switching back to DVD mode. This button works the same as the SELECT button on the remote.

VCR/TV light (red)

Appears if the TV/VCR/DVD is in TV/VCR mode.

REC/OTR light (red)

This light flashes during recording. It lights when the TV/VCR/DVD is in standby mode (power off) for a timer recording.

REC/OTR ● Button (VCR)

Press to start a videotape recording.

Details are on page 29.

Press repeatedly to start a One-Touch Recording. Details are on page 30.

REW ◀◀ Button (VCR)

Press to rewind the tape or to search backward quickly during playback.

Details are on page 42.

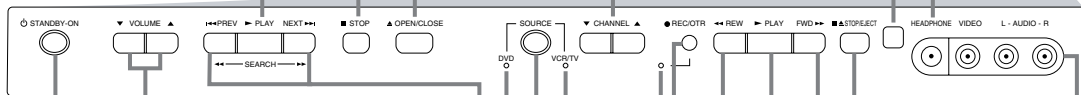
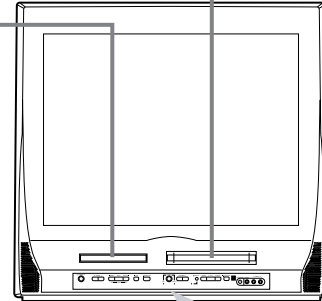

STOP/EJECT ■▲ Button (VCR)

Press to stop tape playback. Press while playback is stopped to remove the tape.

FWD ▶▶ Button (VCR)

Press to fast forward the tape or to search forward quickly during playback. Details are on page 42.

PLAY ► Button (VCR)

Press to start tape playback. Details are on page 17.

VIDEO and AUDIO L/R (left/right) In jacks

Use audio and video cables to connect these jacks to the Audio and Video Out jacks of a Camcorder, DVD player or VCR. This lets you watch materials playing on the other equipment when you choose AUX at the TV/VCR/DVD. Details are on pages 10 and 36.

HEADPHONE jack

Connect headphones (not supplied) here for personal listening.

Remote Sensor

Receives a signal from your remote control so you can operate the TV/VCR/DVD from a distance.

Rear Panel 15

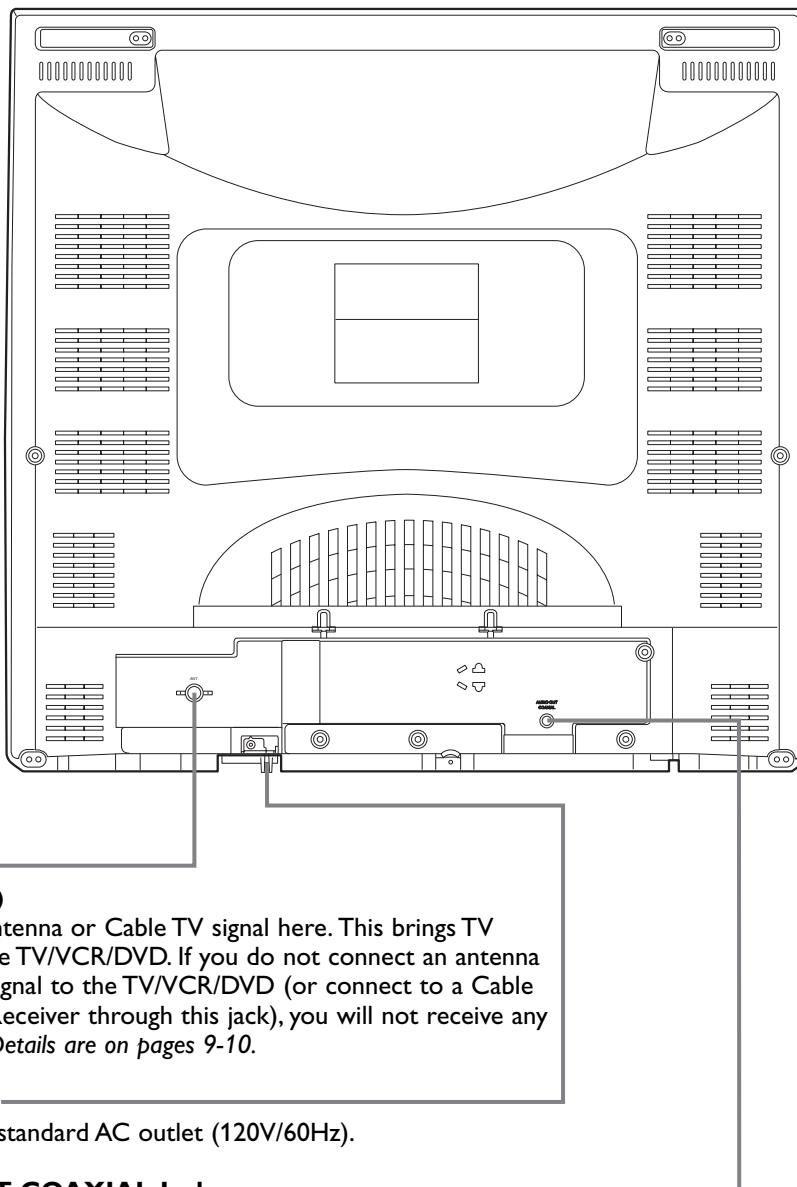

ANT. Jack (Antenna In)

Connect an antenna or Cable TV signal here. This brings TV channels to the TV/VCR/DVD. If you do not connect an antenna or Cable TV signal to the TV/VCR/DVD (or connect to a Cable Box/Satellite Receiver through this jack), you will not receive any TV channels. *Details are on pages 9-10.*

Power Cord

Connect to a standard AC outlet (120V/60Hz).

AUDIO OUT COAXIAL Jack

Connect this jack to a Digital Stereo using a digital audio coaxial cable (not supplied). Use this connection if the Stereo has Dolby Digital compatibility and has a Digital Coaxial Audio In jack. You may also use this connection when connecting the TV/VCR/DVD to a Mini-Disc or Digital Audio Tape deck. *Details are on page 11.*

16 Watching TV

The unit selects available TV channels automatically when you connect an Antenna or Cable TV signal to it. To reset TV channels, see page 20.

If you are using a Cable Box or Satellite Receiver, you do not need to set channels at the TV/VCR/DVD.

1 Press **STANDBY-ON**  to turn on the TV/VCR/DVD.

2 To watch TV, press **CH. ▲/▼** to select memorized channels. Memorized channels are those that appear when you flip through channels. If a channel is skipped, you still can use the Number buttons to select it. This is a non-memorized channel; it may have weak reception in your area.

To update your memorized and non-memorized channels, see page 19.

Remember, if you are using a Cable Box/Satellite Receiver, set the TV/VCR/DVD to channel 3, 4 or AUX. Change channels at the Cable Box/Satellite Receiver.

3 Press **VOL. ▲/▼** to adjust the volume.

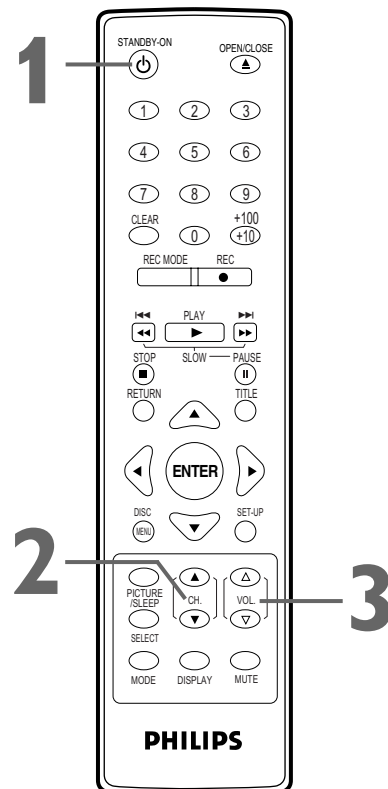
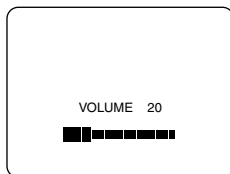

Channel Selection

- To select the memorized channels, press CH. ▲/▼ or the Number buttons.
- The deleted channels can only be selected with the Number buttons.

DTV

- When selecting the channels with CH. ▲/▼, the major channel selection will be followed by the minor channel selection.
- When selecting the channels with the Number buttons, enter the major channel number followed by the minor channel number. For example, if the channel you want to select is 12 (major)-3 (minor), press 1 → 2 → 0 → 3. (You must press 0 first when entering a single digit channel number.)

Playing a Videotape 17

Follow these steps to simply play a videotape. *Videotape playback options are on pages 37-43.*

- 1** Insert a videotape in the cassette compartment of the TV/VCR/DVD. The power will come on. If the tape's record tab is missing, playback should start automatically.
- 2** If playback does not start automatically, press **PLAY ►** to start playback.
- 3** Press **STOP ■** to stop playback.
- 4** Press **◀◀/◀** to rewind the tape.
Press **▶/▶▶** to fast forward the tape.
- 5** Press **STOP/EJECT ■▲** on the front of the TV/VCR/DVD to remove the tape.

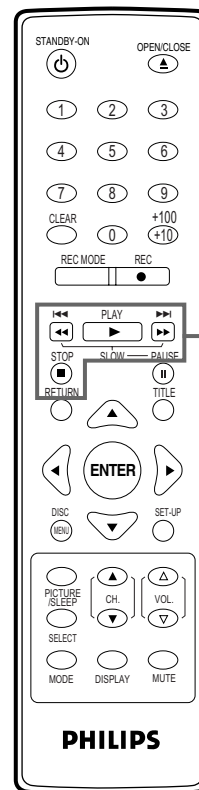



Helpful Hints





- If the tape you want to play is already in the TV/VCR/DVD, turn on the power. Press **SELECT** to choose TV/VCR mode (the red VCR/TV light will be on), then press **PLAY ►**.
- When you play an S-VHS format tape, you cannot get the high resolution that would be available on an S-VHS VCR. Noise lines (black and white streaks) may appear in the picture.
- If you press **SELECT** while playing a videotape, playback will stop and the unit will switch to DVD mode. This will happen also if you press **PLAY ►** (DVD) or **OPEN/CLOSE ▲** (DVD) during videotape playback.

18 Playing a Disc

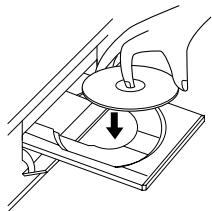
Before you begin, turn on the power of other equipment connected to the TV/VCR/DVD. Set a stereo (if applicable) to the correct sound source or channel. *Details are on page 11.*

- 1** Press **STANDBY-ON**  to turn on the **TV/VCR/DVD**. The unit will be in TV/VCR mode. The red VCR/TV light will be on.
- 2** Press **SELECT** repeatedly to put the **TV/VCR/DVD** in **DVD mode**. The green DVD light will appear on the front of the TV/VCR/DVD.
- 3** Press **OPEN/CLOSE** .
- 4** Place a disc into the tray.
Some DVDs are recorded on both sides. Make sure the label of the side you want to play is facing up.
Or, if the DVD is recorded on only one side, place the disc in the tray with the label facing up and the shiny side facing down.





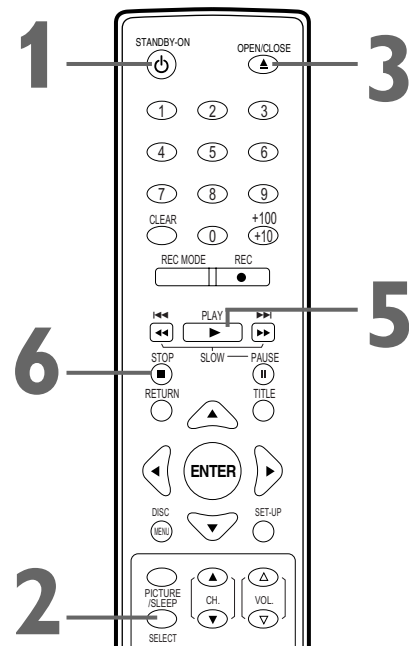

- 5** Press **PLAY** . The tray will close and playback will begin. If playback does not start automatically, press **PLAY**  again.
If a DVD menu appears instead, see page 58.
To play MP3, Windows Media™ Audio or JPEG files, see page 69.
You also can close the tray by pressing **OPEN/CLOSE** .
- 6** Press **STOP**  to stop playback. If playback remains stopped for 5 minutes, the DVD screen will dim. If playback is stopped for 20 minutes with no activity at the TV/VCR/DVD, the unit will turn off.

REMINDER: Only certain discs will play.
See page 7 for details.



Helpful Hints

- Even if you turn off the unit in DVD mode, if you turn it on again with the **STANDBY-ON**  button, it will be in TV/VCR mode. If the unit was shut down by unplugging the power cord or due to a power failure, it will be in DVD mode when you turn it on again.
- An "X" will appear on the screen when you try to access a feature that is not available. This is not a problem with the TV/VCR/DVD.
- If a disc is dirty or scratched, the picture may be distorted or playback may stop. Remove the disc and try a different one.
- Pressing **OPEN/CLOSE**  (DVD) or **PLAY**  (DVD) will turn on the unit in DVD mode (not TV/VCR mode).
- If a disc has multiple layers, the picture may freeze occasionally. This happens when the first layer switches to the second layer. This is not a malfunction.
- Pressing **SELECT** during disc playback stops disc playback and switches the unit to TV/VCR mode. Pressing **PLAY**  (VCR) on the front of the unit during disc playback stops disc playback and starts tape playback.

Menu Language, Auto Channel Preset 19

Menu Language

This affects the language of the TV/VCR/DVD's Setup menus and On-Screen Display terms. This does not alter the language of TV programming, videotapes, discs or closed captioning.

1 Press SET-UP.

2 Press ▲ or ▼ to select LANGUAGE.

In TV/DTV/AUX Mode

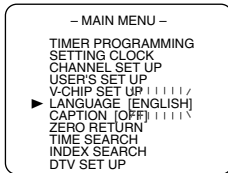

In DVD Mode

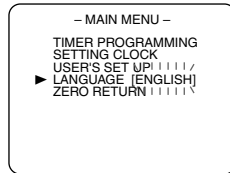

DTV SET UP will show only in DTV Mode.

3 Press ENTER repeatedly to select ENGLISH, ESPAÑOL or FRANÇAIS. The selected language will appear inside the [].

This will be the language of the TV/VCR/DVD Setup menus in both TV/VCR and DVD modes.

4 Press SET-UP to exit the menu.

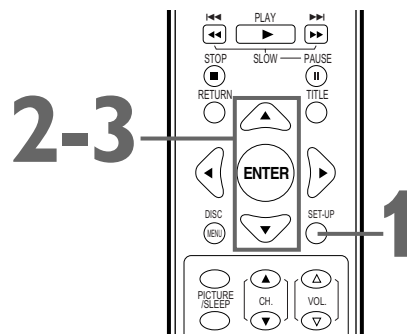
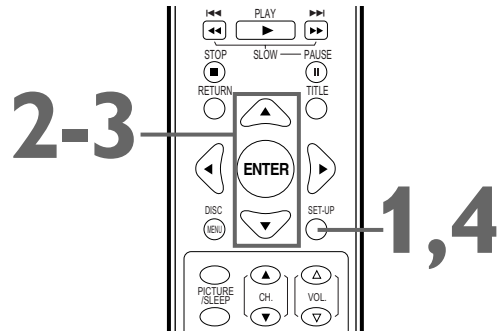

Auto Channel Preset

To automatically preset only the channels which are available in your area, follow the steps below.

- Before you begin, put the TV/VCR/DVD in TV/VCR mode. Press SELECT so the red VCR/TV light appears on the front of the TV/VCR/DVD.

1 Press SET-UP.

2 Press ▲ or ▼ to select CHANNEL SET UP. Then, press ENTER.

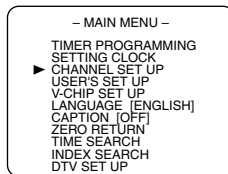

DTV SET UP will show only in DTV Mode.

3 Press ▲ or ▼ to select your desired preset type. Press ENTER.

In TV Mode

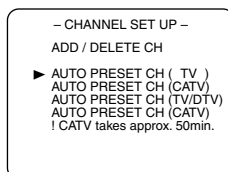

In DTV Mode

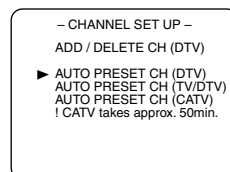

Auto scanning will start.

When scanning is complete, the TV/VCR/DVD will go to the lowest available channel. Use CH. ▲/▼ to scan memorized channels. You can select non-memorized channels with the Number buttons.

Helpful Hints

- The TV/VCR/DVD cannot change channels at the Cable Box or Satellite Receiver. Set the TV/VCR/DVD to 3, 4 or AUX. Change channels at the Cable Box/Satellite Receiver.
- Channel settings will be saved even if the power fails.
- If you have Spanish or French menus and need English, press SET-UP. Press ▲ or ▼ to select IDIOMA or LANGAGE. Press ENTER to select ENGLISH. Press SET-UP to remove the menu.
- You cannot reset TV channels when the unit is in DVD mode.
- If you press STANDBY-ON or SET-UP during scanning, the AUTO PRESET will be canceled.
- With regard only to the digital CH, even after the scanning is complete if you unplug the AC power cord before turning off the unit by pressing STANDBY-ON, the AUTO PRESET CH memory may be lost.
- If there is no TV signal input, "NO TV SIGNALS" will appear on the display after the completion of channel scanning.
- If you selected AUTO PRESET CH (TV/DTV), when the scanning and memorizing are completed, the memorized smallest channel in the analog broadcasting will be displayed. If no analog channel is memorized, the memorized smallest channel in the digital broadcasting will be displayed.

TV/VCR/DTV

20 Adding/Deleting Channels

You can delete TV channels you no longer receive or seldom watch. Or, you can add more channels if the TV/VCR/DVD did not memorize all your favorite channels.

- Before you begin, press **SELECT** to put the TV/VCR/DVD in TV/VCR mode. The red VCR/TV light will appear.

1 Press **SET-UP**.

2 Press **▲** or **▼** to select **CHANNEL SET UP**. Then, press **ENTER**.

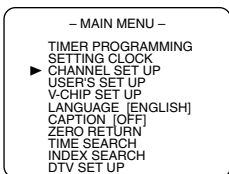

DTV SET UP will show only in DTV Mode.

3 Press **▲** or **▼** to select **ADD/DELETE CH**. Then, press **ENTER**.

In TV Mode

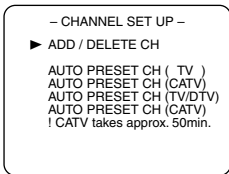

In DTV Mode

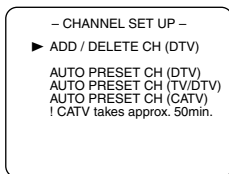

The menu will disappear and a channel number will appear, along with ADD/DELETE. The broadcast being received will show in the background.

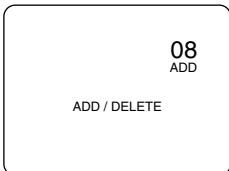

4 Use the **Number** buttons to select the channel you wish to add or delete. To select the channel to add, you also can use **▲** or **▼**, or **CH. ▲/▼**.

5 Press **ENTER** to select **ADD** or **DELETE**. Color of channel numbers displayed at the right top of the screen indicates the following:
 Blue/Green: The selected channel will be added.
 Pink/Red: The selected channel will be deleted.
 To add or delete another channel, repeat steps 4-5.

6 Press **SET-UP** when you are finished.

Major Channel/Minor Channel

In the DTV broadcasting, one channel may consist of one main channel and multiple sub-channels depending on the airtime. In this case, the main channel is called major channel and the sub-channel is called minor channel.

On how to select channel, see **Channel Selection** on page 16.

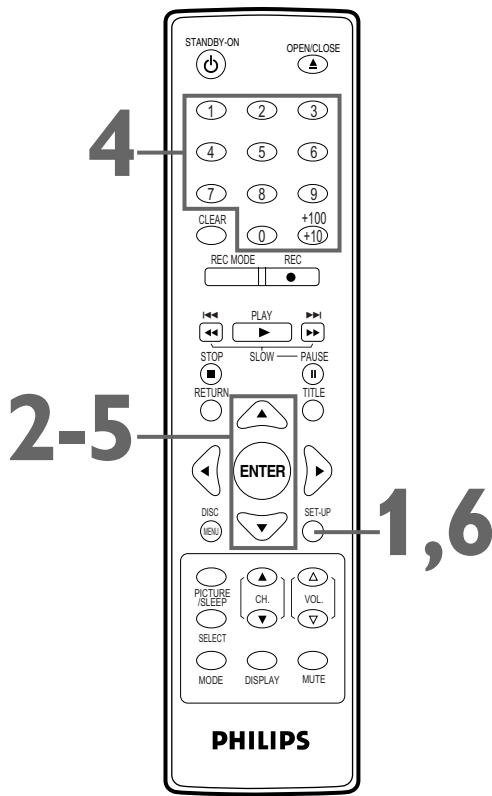

Helpful Hints

- If you connected an Antenna to the TV/VCR/DVD, channels 2-69 will be available to add or delete. If you connected to Cable TV, channels 1-125 will be available.
- This function will not operate when the unit is in DVD mode.
- In the digital mode (DTV), you can add or delete channels only for major channel.
- Once you delete a DTV channel, you cannot add the channel again without performing Auto Channel Preset. See page 19.

Setting the Clock 21

Manual Clock Setting

You must set the clock before you can do a timer recording. Set the clock manually. Afterward, use Auto Clock to monitor the time. *Details are on pages 23-24.*

If you do not receive a PBS station that carries time signals, you cannot use Auto Clock. Set AUTO CLOCK to OFF. The time will remain as you set it manually.

1 Press SET-UP.

2 Press ▲ or ▼ to select SETTING CLOCK. Then, press ENTER.

In TV/DTV/AUX Mode

```

- MAIN MENU -
▶ TIMER PROGRAMMING
  SETTING CLOCK
  CHANNEL SET UP
  USER'S SET UP
  V-CHIP SET UP
  LANGUAGE [ENGLISH]
  CAPTION [OFF]
  ZERO RETURN
  TIME SEARCH
  INDEX SEARCH
  DTV SET UP
  
```

In DVD Mode

```

- MAIN MENU -
▶ TIMER PROGRAMMING
  SETTING CLOCK
  USER'S SET UP
  LANGUAGE [ENGLISH]
  ZERO RETURN
  
```

DTV SET UP will show only in DTV Mode.

3 Press ▲ or ▼ to select MANUAL CLOCK SET. Then, press ENTER.

```

- SETTING CLOCK -
AUTO CLOCK [ON]
AUTO CLOCK CH SEARCH
AUTO CLOCK CH [ 02]
▶ MANUAL CLOCK SET
D.S.T. [OFF]
TIME ZONE [OFF]
  
```

4 While the MONTH space is flashing, press ▲ or ▼ until the correct month appears. Then, press ►.

```

- MANUAL CLOCK SET -
MONTH DAY YEAR
05 - - - - -
HOUR MINUTE
- - : - - -
  
```

5 Likewise, set the DAY, YEAR and HOUR.

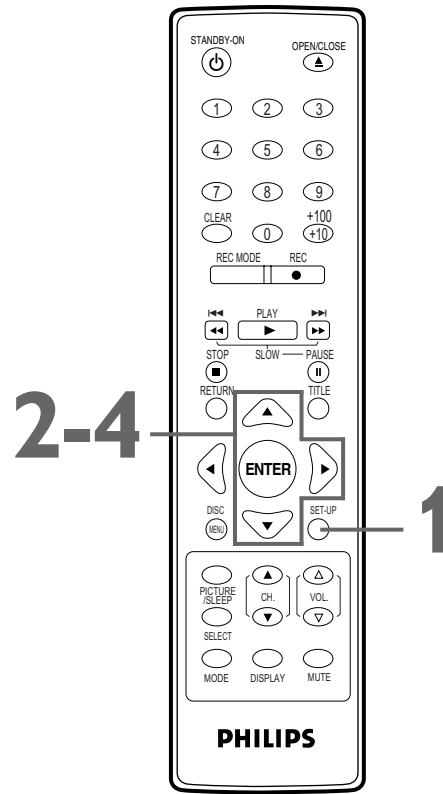

Instructions continue on the next page.

TV/VCR/DTV

22 Setting the Clock (cont'd)

Instructions continued from the previous page.

6 Finally, set the **MINUTE** with ▲ or ▼. Then press **SET-UP**.

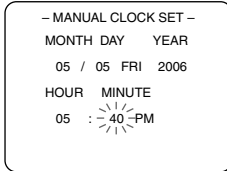

Although seconds are not displayed, they begin counting from 0 when you press **SET-UP**. Use this action to synchronize the clock exactly. Press **DISPLAY** to see the current time on the screen. Details are on page 27.

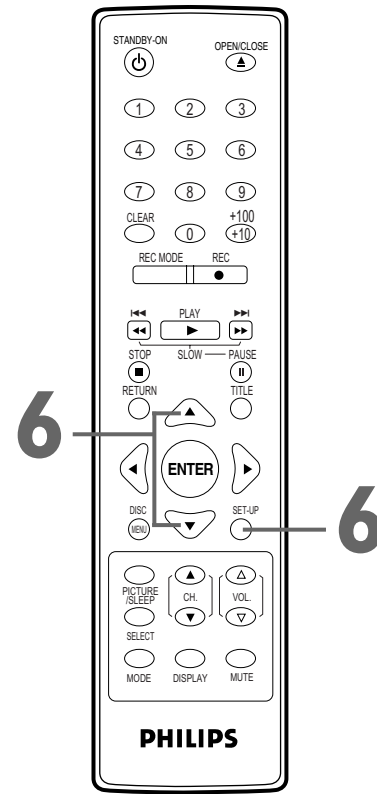

Helpful Hints

- You may have to reset the clock after a power failure.
- To adjust the clock later, follow steps 1-3 on page 21. Then press ◀ or ▶ to select the item you want to change. Enter the correct information by pressing ▲ or ▼. Press **SET-UP** when you are finished.

Setting the Clock (cont'd) 23

Auto Clock Setting

You can have the TV/VCR/DVD adjust the clock using your PBS channel. Once you set the clock manually, the TV/VCR/DVD will monitor the correct time and date broadcast by the PBS station.

Before you begin ...

- Turn on the TV/VCR/DVD power.
- Connect the antenna/Cable TV signal.
Details are on pages 9-10.
- Turn on the Cable Box/Satellite Receiver (if applicable).
- Set up the TV channels. *Details are on pages 19-20.*
- Set the clock manually. *Details are on pages 21-22.*
- **Press SELECT to put the TV/VCR/DVD in TV/VCR mode. The red VCR/TV light will appear.**

1 Press **SET-UP**.

2 Press **▲** or **▼** to select **SETTING CLOCK**.
Press **ENTER**.

In TV/DTV/AUX Mode

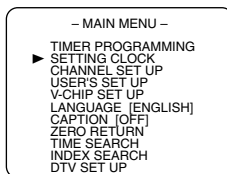

In DVD Mode

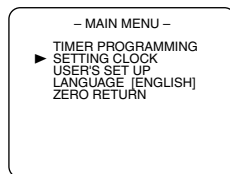

DTV SET UP will show only in DTV Mode.

3 Confirm **AUTO CLOCK** is **ON**. If not, press **ENTER** to select **ON**.

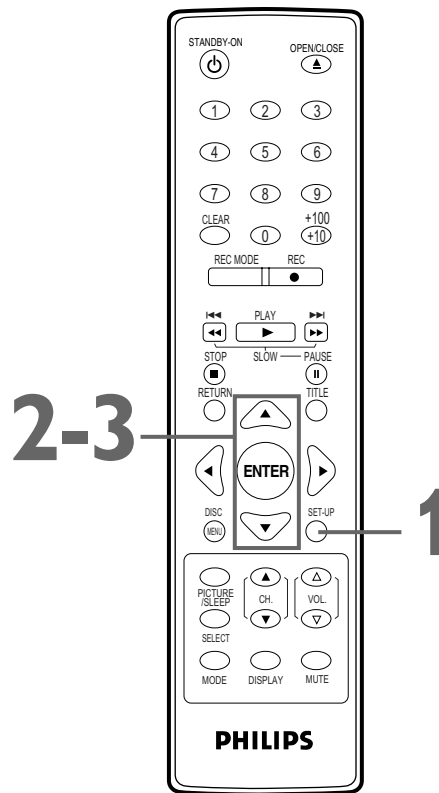
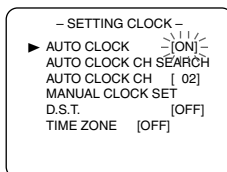

Instructions continue on the next page.

TV/VCR/DTV

24 Setting the Clock (cont'd)

Instructions continued from the previous page.

4 If you already know your PBS channel number, skip ahead to step 8. If you do not know the channel number of your PBS station, press **▼** to select **AUTO CLOCK CH SEARCH**. Then press **ENTER**.

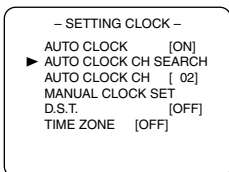

- The TV/DVD/VCR will search for a channel that carries a time signal. Channels that carry the time will appear at the top of the screen. Use one of these channels when you enter your **AUTO CLOCK CH** at step 9. This may take several minutes. An “_ _” appears in the lower left corner of the screen when the search is complete.

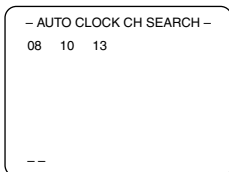

5 Press **SET-UP** to remove the **AUTO CLOCK CH SEARCH** screen.

6 Press **SET-UP** to access the menu again.

7 Press **▲** or **▼** to select **SETTING CLOCK**. Then, press **ENTER**.

8 Press **▲** or **▼** to select **AUTO CLOCK CH**, then press **ENTER**.

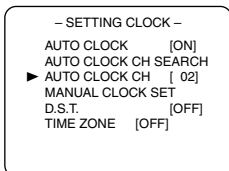

9 Press **◀** or **▶** until the channel number of your PBS station appears. Use one of the channel number you found at step 4.

10 Press **SET-UP** to remove the menu.

11 Press **STANDBY-ON** to turn off the TV/VCR/DVD and let the PBS channel update the clock.

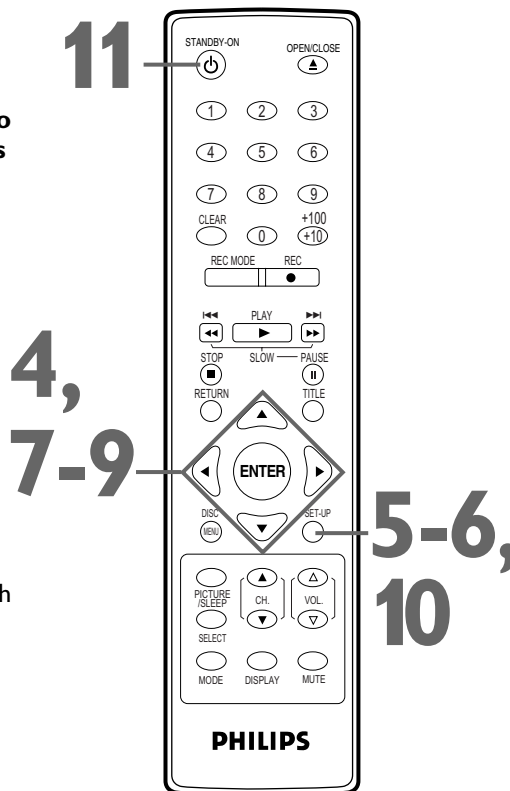

Helpful Hints

- During the Auto Clock Channel Search, the picture may be distorted. This is normal.
- If there are no PBS stations available, set **AUTO CLOCK** to **OFF**. Set the clock manually.
- If the TV/VCR/DVD is connected to a Cable Box or Satellite Receiver, select the local PBS station on the Cable Box/Satellite Receiver. Set the TV/VCR/DVD to the output channel of the Cable Box/Satellite Receiver (03, 04 or AUX).

Daylight-Savings Time 25

When Daylight-Savings Time (D.S.T.) is ON, the clock will move forward 1 hour on the first Sunday in April and move back 1 hour on the last Sunday in October.

To turn Daylight-Savings Time ON or OFF, follow the steps below.

1 Press **SET-UP**.

2 Press **▲** or **▼** to select **SETTING CLOCK**. Then, press **ENTER**.

In TV/DTV/AUX Mode

```

- MAIN MENU -
▶ TIMER PROGRAMMING
  SETTING CLOCK
  CHANNEL SET UP
  USER'S SET UP
  V-CHIP SET UP
  LANGUAGE [ENGLISH]
  CAPTION [OFF]
  ZERO RETURN
  TIME SEARCH
  INDEX SEARCH
  DTV SET UP
  
```

In DVD Mode

```

- MAIN MENU -
▶ TIMER PROGRAMMING
  SETTING CLOCK
  USER'S SET UP
  LANGUAGE [ENGLISH]
  ZERO RETURN
  
```

DTV SET UP will show only in DTV Mode.

3 Press **▲** or **▼** to select **D.S.T.** Then, press **ENTER** until **ON** appears beside **D.S.T.** Or, press **ENTER** so **OFF** appears beside **D.S.T.** if you want to disable this feature.

```

- SETTING CLOCK -
AUTO CLOCK [ON]
AUTO CLOCK CH SEARCH [ 02]
MANUAL CLOCK SET
▶ D.S.T. [ON]
  TIME ZONE [ALASKA]
  
```

4 Press **SET-UP** to remove the menu.

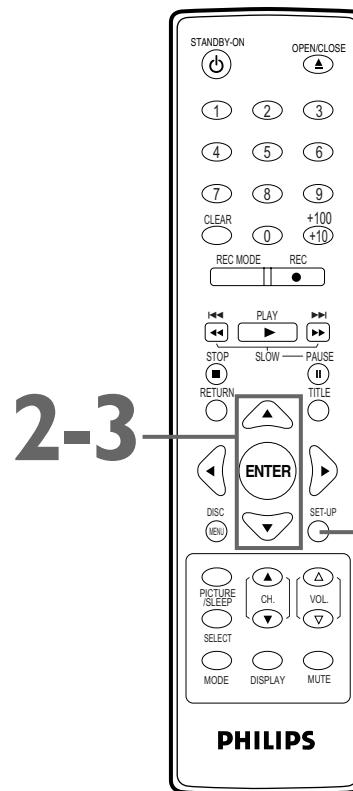

TV/VCR/DTV

26 Time Zone

You must select the time zone of your area to ensure the proper performance of the clock.

1 Press SET-UP.

2 Press ▲ or ▼ to select SETTING CLOCK. Then press ENTER.

In TV/DTV/AUX Mode

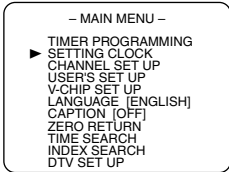

In DVD Mode

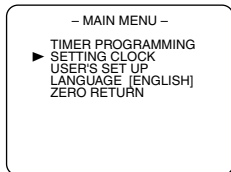

DTV SET UP will show only in DTV Mode.

3 Using ▲ or ▼, select TIME ZONE.

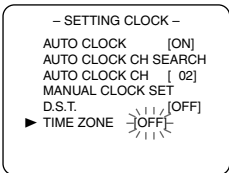

4 Everytime you press ENTER, the TIME ZONE will switch as below.

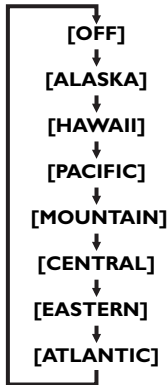

5 To exit the menu, press SET-UP.

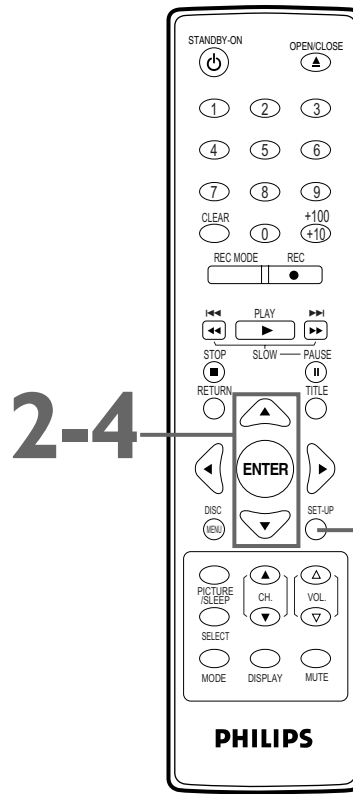

Helpful Hint

- Based on the world standard time information acquired from digital broadcasting, the time difference will be adjusted as below.

OFF	0 hour
ALASKA	-9 hours
HAWAII	-10 hours
PACIFIC	-8 hours
MOUNTAIN	-7 hours
CENTRAL	-6 hours
EASTERN	-5 hours
ATLANTIC	-4 hours

Status Displays 27

Status Displays

To see the Videotape Counter, Clock or Channel number on the screen in TV/VCR mode, press DISPLAY repeatedly. The following will occur when Closed Captions are OFF.

- 1 Press **DISPLAY** once to see the **Videotape counter**. After 5 seconds, only the counter will remain on the screen.

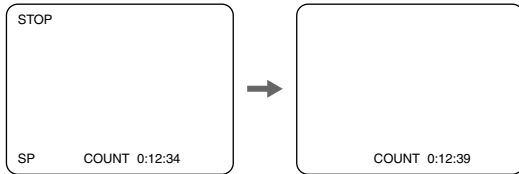

- 2 Press **DISPLAY** again to see the **current time and TV channel**. After 5 seconds, only the clock and channel number will remain on the screen. To clear them, press **DISPLAY** again.

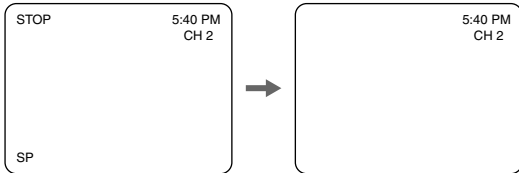

- If you press **DISPLAY** when Closed Captions are ON, all the status information will appear for 5 seconds. After 5 seconds, they will clear from the screen. *Closed Caption details are on pages 44-47.*

DTV

In the digital mode, the detailed information for the currently selected channel such as the program guide is displayed.

- 1 Every time you press **DISPLAY**, the display mode will be switched as below.

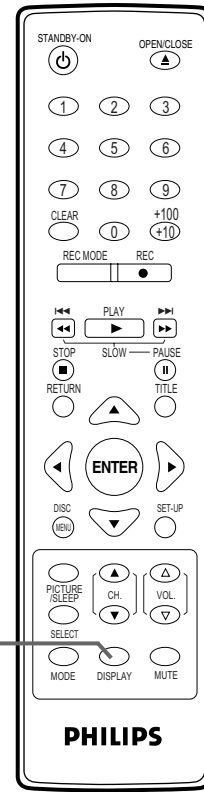
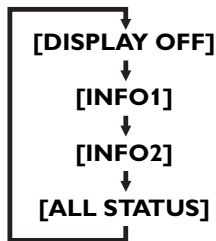

1-2

Helpful Hints

- When the program guide is displayed in more than 6 lines, use **ENTER** or **RETURN** and scroll for reading.
- "No description provided." is displayed when the program guide is not provided.
- While the information is displayed in the **INFO2** mode, the Closed Caption function is interrupted.

Instructions continue on the next page.

TV/VCR/DTV

28 Status Displays (cont'd)

Instructions continued from the previous page.

The following information is displayed in the INFO1 mode.

- (1) Channel number
- (2) Broadcast station
- (3) Program title (max. 2 lines displayed)
- (4) Audio language ("OTHER" is displayed when the audio language cannot be acquired, or the acquired languages are other than ENGLISH, SPANISH or FRENCH.)
- (5) Program air time

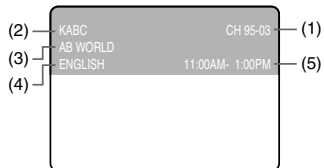

The program guide added to the displayed information in the INFO1 mode is displayed in the INFO2 mode.

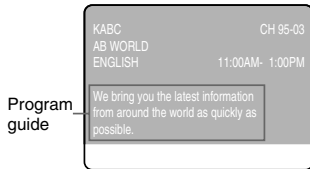

Picture Controls

Follow these steps to adjust the TV/VCR/DVD's brightness, sharpness, tint, color or contrast.

- 1** Press **PICTURE/SLEEP** twice.
- 2** Within 5 seconds, press **▲** or **▼** to select the picture control you want to adjust. You can select BRIGHT, CONTRAST, COLOR, TINT or SHARPNESS.

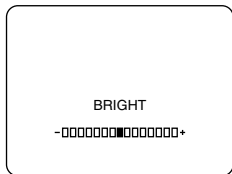

- 3** Within 5 seconds, press **◀** or **▶** to adjust the picture control.

	◀	▶
BRIGHT	to decrease brightness	to increase brightness
CONTRAST	to decrease contrast	to increase contrast
COLOR	to decrease color	to brighten color
TINT	to add purple	to add green
SHARPNESS	to make soft	to make clear

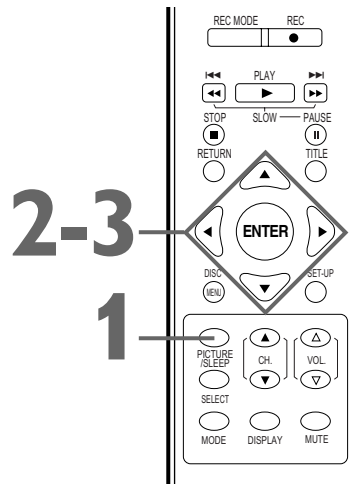

Helpful Hint

- **Degaussing:** Magnetism from nearby appliances and speakers might affect the color of the TV picture. If this happens, move the TV/VCR/DVD away from the appliance. If the color is still not correct, disconnect the power cord for 30 minutes. After 30 minutes, try using the unit again.

Videotape Recording 29

- 1 Place a tape with its record tab intact in the cassette compartment of the TV/VCR/DVD.**
The TV/VCR/DVD power will come on.
If the power is already on and a videotape is in the unit, make sure the unit is in TV/VCR mode.
Press SELECT so the red VCR/TV light appears on the front of the unit.
- 2 Press REC MODE until the desired tape speed (SP or SLP) appears in the bottom left corner of the screen.** See tape speed details below.
- 3 Press CH. ▲/▼ or the Number buttons to select the channel you want to record.**
You cannot change channels during recording. You can only record and view one TV channel at a time.
- 4 Press REC ● once to start recording.**
The REC/OTR light will flash on the front of the TV/VCR/DVD. (If the tape does not have a record tab, the tape will eject. Insert another tape.)
- 5 To pause the recording, press PAUSE II. To resume recording, press PAUSE II again or press REC ●.**
- 6 To stop recording, press STOP ■.**

- 1** Put a videotape in the TV/VCR/DVD.

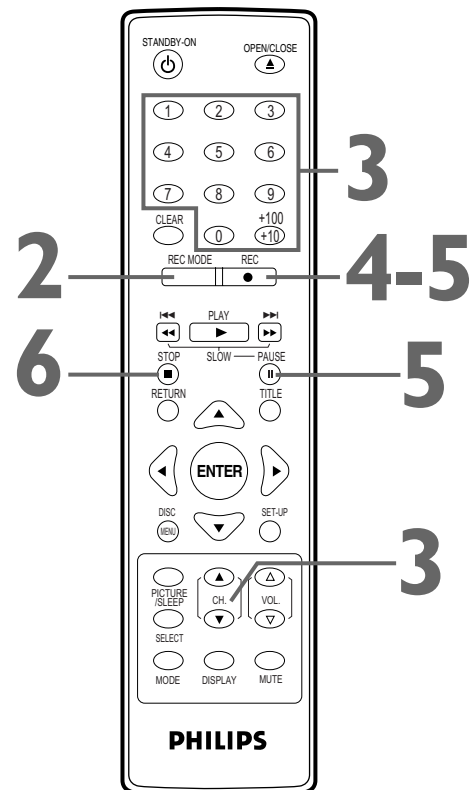

Tape Speeds

This chart shows the recording/playback time for 3 types of video cassettes (T160, T120 and T60). There are 3 playback speeds: SP, LP and SLP. A tape will play only in the speed in which it was recorded. When recording, you can change the tape speed using REC MODE. You cannot record in LP speed on this TV/VCR/DVD.

The slower the speed, the more programming you can fit on the tape. SLP is the slowest speed.

Tape Speed	Cassette type / Playback Time		
	T160	T120	T60
SP(Standard Playback)	2 hrs. 40 mins.	2 hrs.	1 hr.
LP(Long Playback) (playback only)	5 hrs. 20 mins.	4 hrs.	2 hrs.
SLP (Super Long Playback)	8 hrs.	6 hrs.	3 hrs.

Helpful Hints

- You cannot record DVD contents onto a videotape using this unit.
- Recording options are on pages 30-35.
- If you pause a recording for 5 minutes, the unit will start recording again automatically.
- You can change the tape speed by pressing REC MODE while a recording is in progress. Some distortion may appear on the tape.

TV/VCR/DTV

30 One-Touch Recording

A One-Touch Recording (OTR) is an immediate timed recording from 30 minutes to 8 hours long.

Before you begin ...

- Turn on the TV/VCR/DVD.
- Press SELECT to put the unit in TV/VCR mode. The red VCR/TV light will appear on the front of the unit.
- Insert a videotape with its erase prevention tab in place. Details are on page 8.

- 1 Press the Number buttons or CH. ▲/▼ to select the channel you want to record.** Remember, if the TV/VCR/DVD is connected to a Cable Box/Satellite Receiver, the TV/VCR/DVD must be on channel 3, 4 or AUX. Select the channel you want to record at the Cable Box/Satellite Receiver. Details are on page 9.

- 2 Press REC MODE to select a tape recording speed (SP or SLP).** Details are on page 29.

- 3 Press REC/OTR ● on the front of the TV/VCR/DVD repeatedly to select a recording length. Recording will start immediately.** Each press of REC/OTR ● will increase the recording time by 30 minutes. The maximum recording length is 8 hours.

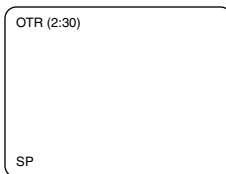

- 4 Press STOP ■ to stop a one-touch recording before its designated end time.** Otherwise, recording will stop at the time you designated. The TV/VCR/DVD will turn off when the OTR ends.

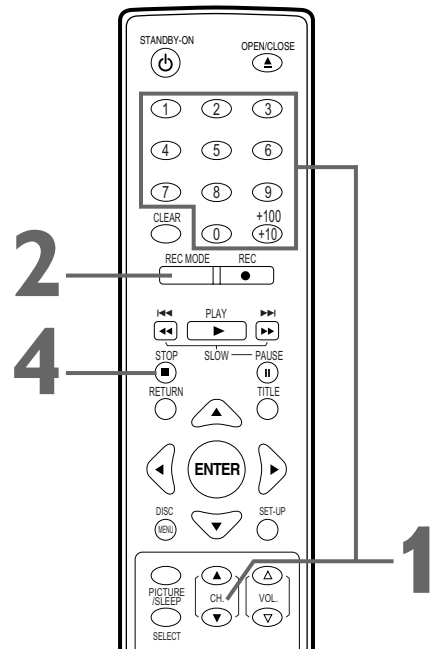

- 3 Press REC/OTR ● on the front of the TV/VCR/DVD.**

Helpful Hints

- You cannot start an OTR with the REC ● button on the remote control.
- To show the remaining recording time, press DISPLAY. OTR and the remaining recording time will appear briefly in the top left corner of the screen.
- If the tape ends before the recording's end time, the TV/VCR/DVD will stop recording, eject the tape, and turn itself off.
- An OTR will continue even if you turn off the TV/VCR/DVD. The flashing REC/OTR light indicates the recording is still in progress.
- To change the recording length while an OTR is in progress, press REC/OTR ● repeatedly.
- You cannot pause an OTR.
- If the preset time for a timer recording comes up during an OTR, the OTR has priority. The timer recording will not take place.

Timer Recording 31

Follow the steps below to program the TV/VCR/DVD to record TV programs while you're away from home. The TV/VCR/DVD will record and turn itself off automatically. You can set a maximum of 8 timer recordings.

Before you begin, make sure ...

- The clock is set. If the clock is not set, the Manual Clock Set menu will appear. See pages 21-22 to set the clock.
- Channels are set. *Details are on page 19.*
- A tape is in the TV/VCR/DVD. Make sure the record tab is intact. *Details are on page 8.*

1 Press SET-UP.

2 Press ▲ or ▼ to select TIMER PROGRAMMING, then press ENTER.

In TV/DTV/AUX Mode

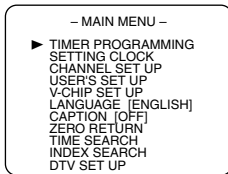

In DVD Mode

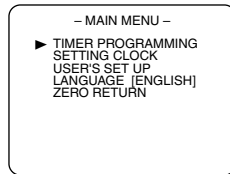

DTV SET UP will show only in DTV Mode.

3 Press ▲ or ▼ to select a program position. Then, press ►.

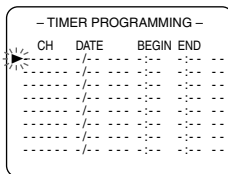

4 With first cell flashing, press ▲ or ▼ to select "D" (for Digital) or "-" (for Analog). Then press ►.

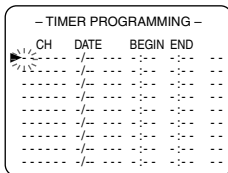

Example: Analog channel is selected.

When you select "D" (Digital) or "-" (for Analog), the channel you were watching last will be entered in the CH field automatically.

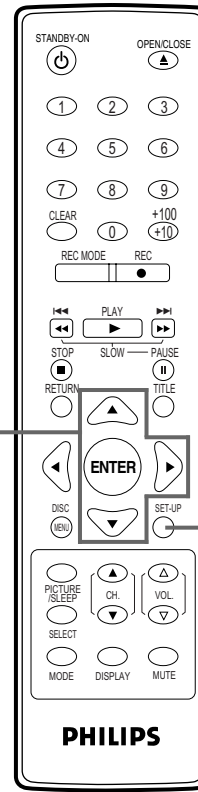

PHILIPS

Helpful Hints

- You cannot access the Timer Programming menu at step 2 if the clock is not set. The Setting Clock menu will appear. Follow the steps on pages 21-24 to set the clock.
- Enter the information while the space is flashing.

Instructions continue on the next page.

TV/VCR/DTV

32 Timer Recording (cont'd)

Instructions continue on the next page.

5 While **CH** is selected, press **▲** or **▼** to select the channel you want to record. Then press **▶**.

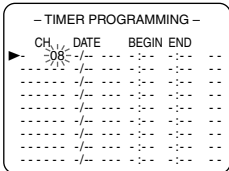

If the TV/VCR/DVD is connected to a Cable Box/Satellite Receiver, the TV/VCR/DVD must be on channel 3, 4 or AUX. Set CH as 03, 04 or AUX in the Timer Programming menu. Choose the channel you want to record at the Cable Box/Satellite Receiver. Leave the Cable Box/Satellite Receiver on for the timer recording. Leave the TV/VCR/DVD set to AUX. (Press SELECT on the remote to choose AUX at the TV/VCR/DVD.) Additional details are on page 9.

6 While **DATE** is selected, press **▲** or **▼** to select the desired date. Then, press **▶**.

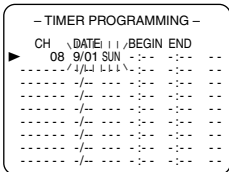

The **DATE** will change in the order described below.

Example: If today is 9/01 (2006)

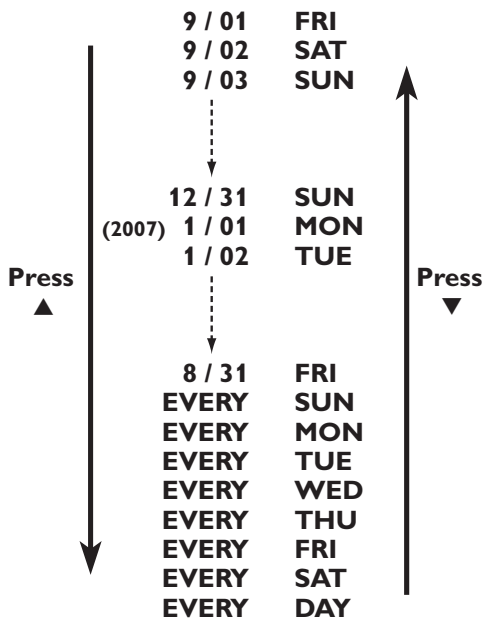

7 Likewise, set the **BEGIN** time and **END** time.

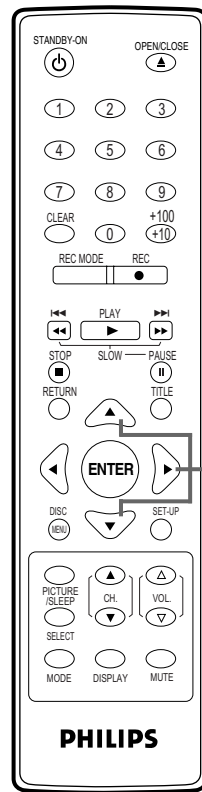

Timer Recording (cont'd) 33

- 8** Finally, set the tape speed (SP or SLP) with ▲ or ▼. Then press ENTER.

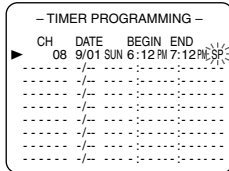

A program is now set.

- 9** Press SET-UP to remove the menu.

- 10** Press STANDBY-ON to turn off the TV/VCR/DVD and set the timer recording. The red REC/OTR light will appear on the front of the TV/VCR/DVD.

You must turn off the TV/VCR/DVD to activate a timer recording. If the power is not off and you continue watching TV, TIMER REC STANDBY starts flashing on the screen 2 minutes before the programmed start time. In such case, turn off the power to start the timer recording as scheduled.

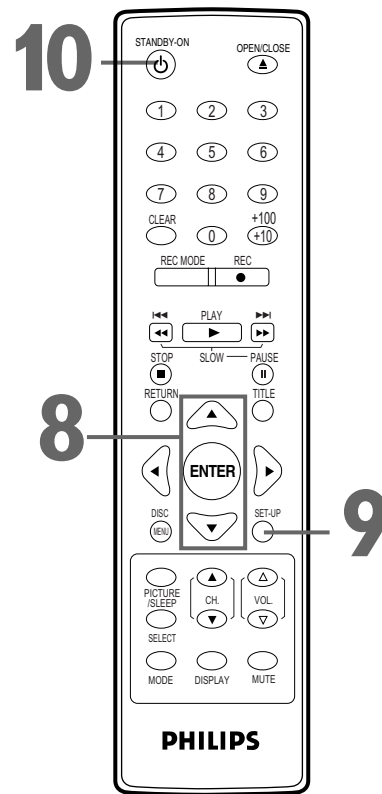

Helpful Hints

- To correct information while setting the Timer Recording, press ◀ to go back one step and select the incorrect information. Press ▲ or ▼ to enter the correct information.
- While a timer recording is in progress, the red REC/OTR light will flash.
- If a timer recording is set for hours or days later, you can use the TV/VCR/DVD until then. Just be sure to turn off the TV/VCR/DVD about 5 minutes before the recording. Set the Cable Box/Satellite Receiver if appropriate.
- If the record tab is missing, the videotape will eject when you press STANDBY-ON to turn off the TV/VCR/DVD. Insert a recordable tape for the timer recording.
- If the tape ends before the recording is complete, the TV/VCR/DVD will stop recording immediately and eject the tape.

TV/VCR/DTV

34 Timer Recording (cont'd)

Extending a Timer Recording

To make a Timer Recording start and end later than originally scheduled, follow these steps.

- 1 With the unit on, press SET-UP. Press ▲ or ▼ to select TIMER PROGRAMMING. Press ENTER.
- 2 Press REC ●, then press ▲ or ▼ to select the desired program.
- 3 Press REC ● again. Each press of REC ● will shift forward the beginning/end time by 10 minutes. If the recording is in progress, each press will shift forward the end time only.
If you adjust the times during recording, the recording speed automatically changes to SLP.
To restore the original recording times, press PAUSE ■■.
- 4 Press SET-UP to remove the menu.
- 5 If the timer recording is scheduled to start later, press STANDBY-ON ○ to turn off the TV/VCR/DVD for the recording.

Correcting a Timer Recording

- 1 With the unit on, press SET-UP. Press ▲ or ▼ to select TIMER PROGRAMMING. Press ENTER.
- 2 Press ▲ or ▼ to select a timer recording, then press ►.
- 3 Press ◀ or ▶ to select the information you want to change.
Press ▲ or ▼ to enter the correct information.
- 4 Press SET-UP to remove the menu.
- 5 Press STANDBY-ON ○ to turn off the TV/VCR/DVD to set the recording.

Cancelling Timer Recordings

To cancel a Timer Recording that is in progress:

- 1 The red REC/OTR light will flash during recording. Press STANDBY-ON ○ to turn on the TV/VCR/DVD, then press STOP/EJECT ■▲ on the front of the TV/VCR/DVD.

To cancel a Timer Recording that has not started:

- 1 With the unit on, press SET-UP.
Press ▲ or ▼ to select TIMER PROGRAMMING. Press ENTER.
- 2 Press ▲ or ▼ to select a timer recording.
- 3 Press CLEAR. All the information for the selected recording will disappear.
- 4 Press SET-UP to remove the menu.

Checking Scheduled Timer Recordings

- 1 With the unit on, press SET-UP.
Press ▲ or ▼ to select TIMER PROGRAMMING.
- 2 Press ENTER. The program details will appear on the screen.
- 3 Press SET-UP to remove the menu.

Timer Recording Auto Return 35

Use this feature to rewind the tape to the beginning of a completed timer recording.

1 Press SET-UP.

2 Press ▲ or ▼ to select USER'S SET UP. Then, press ENTER.

In TV/DTV/AUX Mode

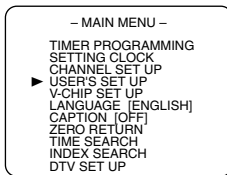

In DVD Mode

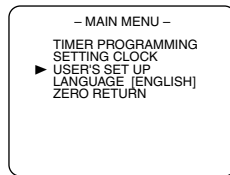

DTV SET UP will show only in DTV Mode.

3 Press ▲ or ▼ to select AUTO RETURN.

4 Press ENTER until ON appears beside AUTO RETURN. To turn off Auto Return, press ENTER to choose OFF instead.

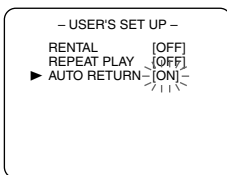

5 Press SET-UP. When AUTO RETURN is ON, when all the timer recordings are completed, the tape will rewind to the beginning of the recorded program(s).

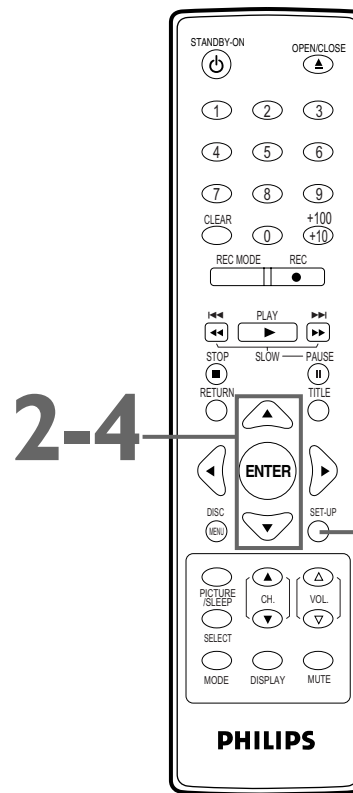

Helpful Hints

- If you press STANDBY-ON  while the tape is rewinding, the rewinding will stop.
- Even if there is a power failure, the TV/VCR/DVD retains the Auto Return Setting.

TV/VCR/DTV

36 Rerecording (Tape Duplication)

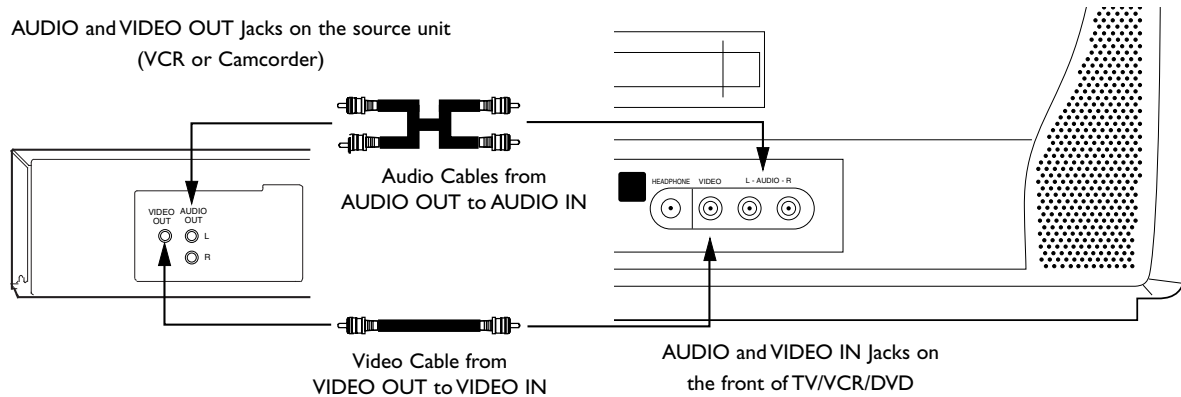

- 1** Make the connections shown above. Use audio and video cables (not supplied). Connect the source unit (VCR or Camcorder) to a power source after connections are made.
- 2** The VCR or Camcorder will play your tape. **Insert a prerecorded tape in the source unit.** If playback begins, press **STOP ■** on the VCR or Camcorder.
- 3** The TV/VCR/DVD will record your tape. **Insert a blank videotape in the cassette compartment of the TV/VCR/DVD.** Make sure the tape's record tab is intact and the TV/VCR/DVD power is on.
- 4** Point the TV/VCR/DVD remote control at the TV/VCR/DVD. Press **SELECT** or **CH. ▲/▼** until **AUX** appears on the screen. The TV/VCR/DVD is now in line input or auxiliary mode.
- 5** Press **REC MODE** until the desired tape speed (**SP** or **SLP**) appears in the lower left corner of the screen.
- 6** Press **PLAY ►** on the VCR or Camcorder and **REC/OTR ●** on your TV/VCR/DVD at the same time. Videotape copying will begin.
- 7** To stop copying, press **STOP/EJECT ■▲** on the TV/VCR/DVD, then stop the tape on the VCR or Camcorder.

Helpful Hints

- Unauthorized recording of copyrighted television programs, videotapes or other materials may infringe on the rights of copyright owners and violate copyright laws.
- Different brands of equipment may operate differently.
- Make sure all connections are secure. Otherwise, you may not record both picture and sound.
- Programs that are copyright protected may not record clearly.
- You cannot record a DVD onto a videotape using this TV/VCR/DVD.
- You can use this connection to simply view tapes playing on a camcorder or VCR at the TV/VCR/DVD. Follow steps 1, 2 and 4 for connections and AUX setup. Then play the tape on the camcorder, etc., as usual.

Repeat Playback 37

Repeat Playback allows you to play a videotape continuously. All Repeat will repeatedly play the tape from the beginning to the end. Blank Repeat will repeatedly play the tape from its beginning to the first part that is blank for more than 10 seconds.

1 Press **SET-UP**.

2 Press **▲** or **▼** to select **USER'S SET UP**. Then, press **ENTER**.

In TV/DTV/AUX Mode

```

- MAIN MENU -
TIMER PROGRAMMING
SETTING CLOCK
CHANNEL SET UP
▶ USER'S SET UP
V-CHIP SET UP
LANGUAGE [ENGLISH]
CAPTION [OFF]
ZERO RETURN
TIME SEARCH
INDEX SEARCH
DTV SET UP
  
```

In DVD Mode

```

- MAIN MENU -
TIMER PROGRAMMING
SETTING CLOCK
▶ USER'S SET UP
LANGUAGE [ENGLISH]
ZERO RETURN
  
```

DTV SET UP will show only in DTV Mode.

3 Press **▲** or **▼** to select **REPEAT PLAY**.

4 Press **ENTER** until **ALL** or **BLANK** appears beside **REPEAT PLAY**. Or, to cancel Repeat Play, press **ENTER** to select **OFF**.

```

- USER'S SET UP -
RENTAL [OFF]
▶ REPEAT PLAY [ALL]
AUTO RETURN [OFF]
  
```

5 Press **SET-UP** to remove the menu.

6 Press **PLAY ▶** to play a videotape. **REPEAT PLAY** will appear on the screen briefly.

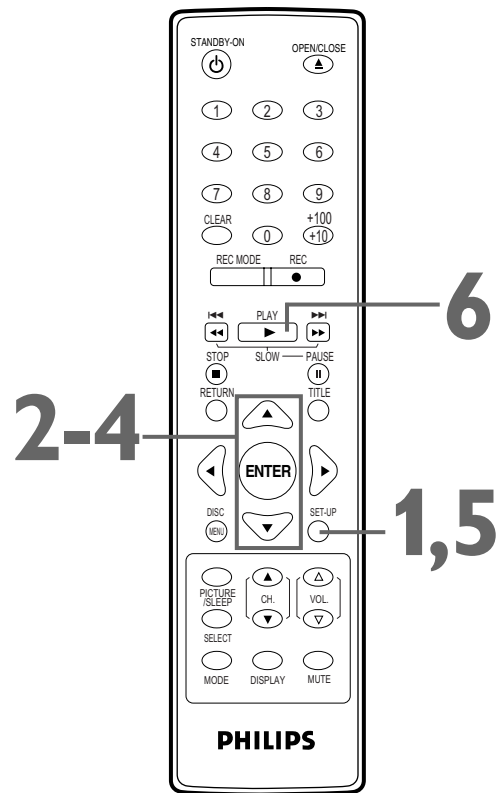

Helpful Hints

- Repeat Playback stays in effect after you turn off the TV/VCR/DVD. The TV/VCR/DVD keeps the Repeat Playback setting even if the power fails.
- If RENTAL is ON, RENTAL PLAY will appear on the screen instead of REPEAT PLAY. Details are on page 38.

TV/VCR/DTV

38 Rental Playback

This function enables you to improve picture quality when playing worn cassettes such as rented videotapes.

1 Press **SET-UP**.

2 Press **▲** or **▼** to select **USER'S SET UP**. Then, press **ENTER**.

In TV/DTV/AUX Mode

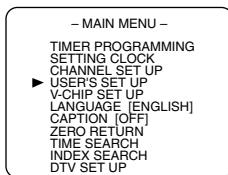

In DVD Mode

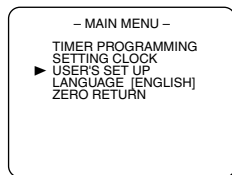

DTV SET UP will show only in DTV Mode.

3 Press **▲** or **▼** to select **RENTAL**. Press **ENTER** until **ON** appears beside **RENTAL**. To turn off Rental, press **ENTER** to choose **OFF**.

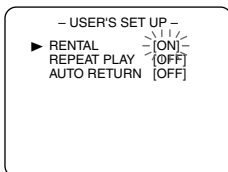

4 Press **SET-UP** to exit the menu.

5 Press **PLAY ►** to start videotape playback. **RENTAL PLAY** will appear briefly on the screen.

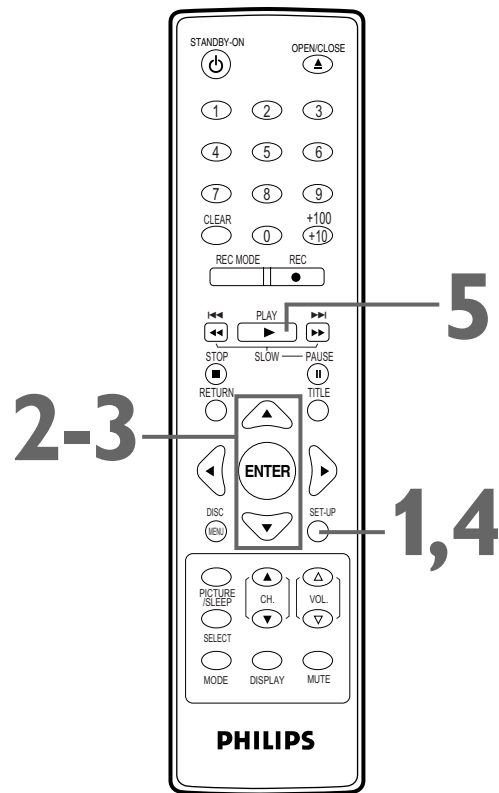

Helpful Hints

- Once you select Rental Playback, it stays in effect even after you turn off the TV/VCR/DVD.
- The TV/VCR/DVD will retain the Rental setting even if the power fails.

Zero Return, Sleep Timer 39

Zero Return

The videotape counter shows the elapsed recording or playback time in hours, minutes and seconds from the point at which the counter was set to 0. The counter time will not change on a blank tape or blank portions on a tape. The “-” before the tape counter indicates the amount of remaining recording/playing time before the counter reaches 0. Follow the steps below to reset the tape counter to 0 at a tape location you want to refer to later.

- 1** Play, rewind or fast forward the tape to the location you would like to refer to later. Press **STOP** ■ to stop the tape.
- 2** Press **CLEAR** once to display the tape counter on the TV screen.
- 3** Press **CLEAR** one more time to set the counter to 0:00:00.
- 4** To return to this same point later, press **SET-UP**. Press **▲** or **▼** to select **ZERO RETURN**. Then, press **ENTER**.

The tape counter will appear on the screen and the TV/VCR/DVD begins rewinding or fast forwarding the tape. When the tape reaches the point at which you set the counter to 0, the tape will stop. Press **PLAY** ► to watch the tape from the designated point.

In TV/DTV/AUX Mode

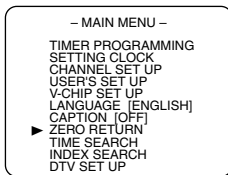

In DVD Mode

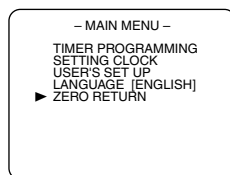

DTV SET UP will show only in DTV Mode.

Sleep Timer

Use the Sleep Timer to program the TV/VCR/DVD to shut off in a certain amount of time.

- 1** Press **PICTURE/SLEEP** once. Sleep information will appear at the bottom of the TV screen. Press **◀** or **▶** to change the amount of time until shut down. Each press of **▶** will increase the time by 30 minutes. You may set the Sleep Timer of 30, 60, 90 or 120 minutes. After 5 seconds, the Sleep Timer information will disappear from the screen. The TV/VCR/DVD will turn itself off after the selected amount of time has passed.

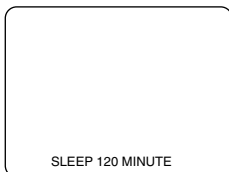

To cancel the Sleep Timer

Press **CLEAR** to set the amount of time to 0 while the Sleep information is displayed on the screen.

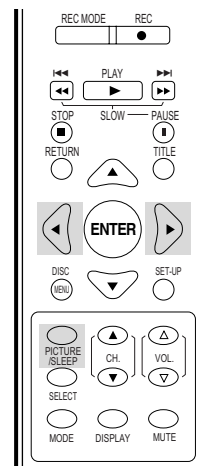
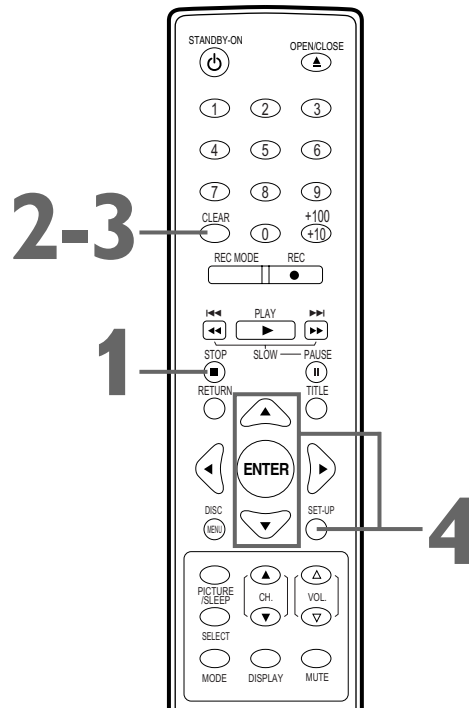

Helpful Hint

- To see how much time remains before the TV/VCR/DVD turns itself off, press **PICTURE/SLEEP** once. The information will disappear automatically in 5 seconds.

TV/VCR/DTV

40 Time Search

Time Search lets you quickly advance the videotape to a position simply by entering the amount of playback time you want to skip.

In the example below, Time Search is set to 2 hours, 50 minutes from the present position.

1 Insert a videotape.

2 Press SET-UP. Press ▲ or ▼ to select TIME SEARCH. Then, press ENTER.

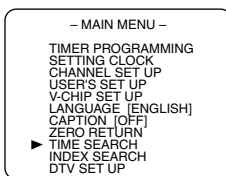

DTV SET UP will show only in DTV Mode.

3 Press ▲ or ▼ until your desired time appears beneath TIME SEARCH at the top of the screen. (Example: 2:50 for 2 hours, 50 minutes) Each press of ▲ or ▼ increases or decreases the length of time by 10 minutes. To cancel the Time Search at this point, press SET-UP.

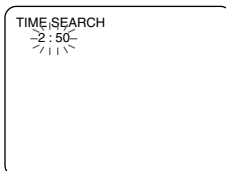

4 Press ◀ or ▶ to rewind or fast forward the tape the length of time you chose. The TV/VCR/DVD will rewind or fast forward the tape the specified amount of time. The time counts down on the screen as the search progresses. When 0:00 is reached, the tape will start playing. Or, to cancel the Time Search before it finishes, press STOP ■.

1 Insert a videotape.

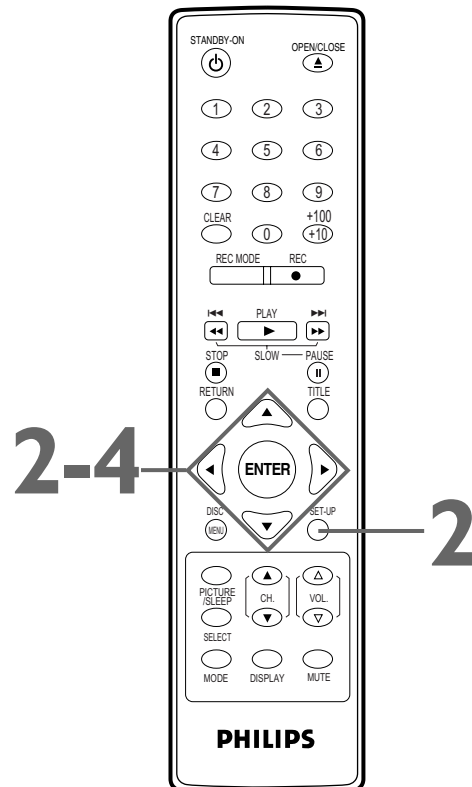

Helpful Hints

- A Time Search can be set up to a maximum of 9 hours 50 minutes in 10-minute increments.
- Time Search will not operate during recording.

Index Search 41

This feature lets you quickly rewind or fast forward to the start of recordings.

- Index Marks are made automatically at the start of all recordings. They are not made where recording pauses. The time gap between Index Marks should be greater than 1 minute for SP recording and 3 minutes for SLP recording. This means recordings should be 1 (SP) or 3 (SLP) minutes long. Otherwise, Index Search may not find the start of the recording. In some cases, Index Marks at the beginning of a videotape cannot be detected.

- 1 Press SET-UP. Press ▲ or ▼ to select INDEX SEARCH. Then, press ENTER.**

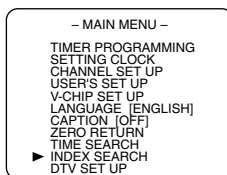

DTV SET UP will show only in DTV Mode.

- 2 Press ▲ or ▼ until the number of programs you want to skip appears beneath INDEX SEARCH.**
To cancel an Index Search at this point, press SET-UP.

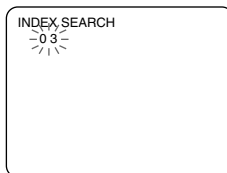

- 3 Press ◀ or ▶.** The TV/VCR/DVD begins rewinding or fast forwarding the videotape to the beginning of the desired program.

- 4** When the program is reached, playback will start.

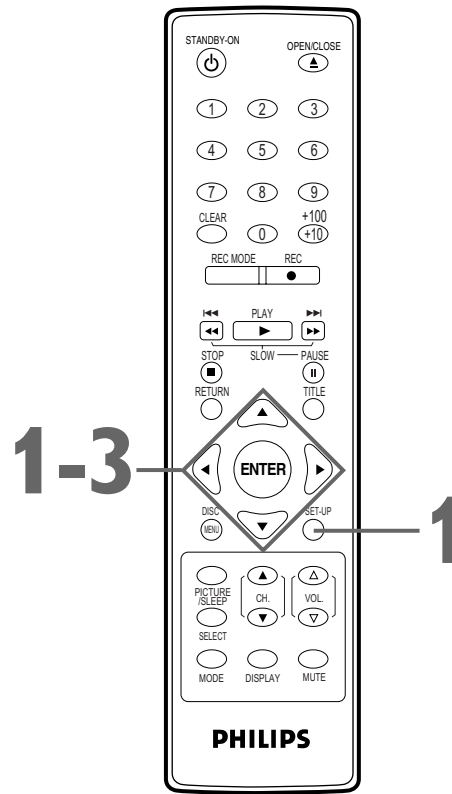

Helpful Hints

- Every time an Index Mark (or recording) is passed, the number beneath INDEX SEARCH on the screen decreases by one.
- A videotape must be in the TV/VCR/DVD for this function to work.
- You may search up to 20 Index Marks.
- This function will not operate during recording.
- To cancel an Index Search, press STOP ■.
- If the end of the tape is reached during an Index Search(forward), the tape will rewind to the beginning automatically. The TV/VCR/DVD will turn off and the tape will eject.

TV/VCR/DTV

42 Videotape Playback Features

Slow Motion

1 Press **PAUSE** **||** during playback to pause the videotape. Then press **▶▶/▶▶** to start slow motion. Sound will be mute during slow motion. Slow motion will stop automatically after 5 minutes to prevent damage to the tape.

2 Press **PLAY** **▶** to return to normal playback.

Forward and Reverse Searching (SP/LP/SLP)

1 During videotape playback, press and release **◀◀/◀◀** or **▶▶/▶▶**. A fast forward or reverse picture search will begin.

2 Press **PLAY** **▶** to return to normal playback.

Super High Speed Searching (LP/SLP)

1 During tape playback, press **◀◀/◀◀** or **▶▶/▶▶**, then press again. The TV/VCR/DVD will search the tape in high speed. Press **◀◀/◀◀** or **▶▶/▶▶** repeatedly to switch between Regular and High Speed Searching.

2 Press **PLAY** **▶** to return to normal playback.

Viewing a Still Picture

1 During tape playback, press **PAUSE** **||**. A still picture will appear on the screen. The picture advances each time you press **PAUSE** **||**. After a tape is paused for 5 minutes, playback will stop automatically. This prevents damage to the tape and TV/VCR/DVD.

2 If the still picture vibrates vertically, stabilize the picture by pressing **CH**. **▲** or **▼**.

3 To release the still picture and return to normal playback, press **PLAY** **▶**.

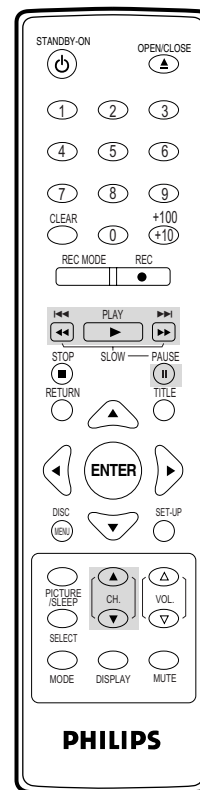

Helpful Hints

- SP/LP/SLP means this feature will work with tapes recorded in Standard Playback, Long Playback or Super Long Playback. LP/SLP means this feature will work with tapes recorded in Long Playback and Super Long Playback. *Tape speed details are on page 29.*
- During forward and reverse searching, horizontal noise bars will appear on the screen.

Automatic Operation Features 43

The following videotape features are available.

Automatic Rewind, Eject, Off

When you play, fast forward or record a videotape to its end, the TV/VCR/DVD will rewind the tape, stop, turn itself off, and eject the tape.

If Repeat Play is activated, playback will start again instead.

Details are on page 37.

The tape will not rewind automatically after a timer recording ends. To rewind a tape after timer recordings, see Auto Return details on page 35.

Automatic Tracking Adjustment

The TV/VCR/DVD automatically adjusts the videotape tracking to give you the best possible picture quality. With some recordings, however, you may get a better picture using the manual tracking controls (see below).

Manual Tracking

To adjust the tracking manually, press CHANNEL ▲/▼ on the front of the TV/VCR/DVD or CH. ▲/▼ on the remote control during playback.

Tracking returns to Automatic Tracking Adjustment when you insert a tape or press STOP ■.

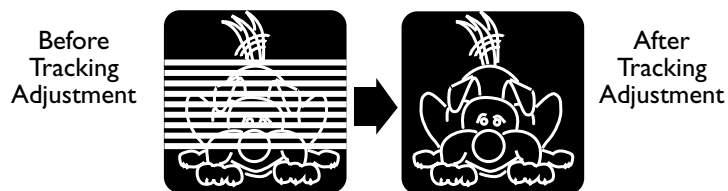

TV/VCR/DTV

44 Closed Captions (TV)

Follow the steps below to select closed captions for TV programming. Not all TV programs and commercials have closed captions or all types of closed captions (second language, half-screen text, etc.). If closed captioning is not broadcast, you cannot receive it. This does not indicate a problem with the TV/VCR/DVD. Check your TV program listings for shows with closed captions.

If the TV/VCR/DVD receives poor quality television signals, the captions may contain errors, or there might be no captions at all. Some possible causes of poor quality signals are:

- Automobile ignition noise
- Electric motor noise
- Weak signal reception
- Multiplex signal reception (ghosts or screen flutter)
- Playing poorly recorded or worn videotapes

- 1 Press SET-UP.**
Press ▲ or ▼ to select **CAPTION**.

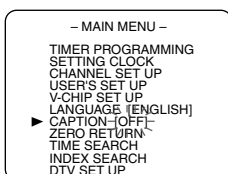

DTV SET UP will show only in DTV Mode.

- 2 Press ENTER repeatedly to select CAPTION1, CAPTION2, TEXT1, TEXT2 or OFF.**

CAPTION1 displays standard closed captions (what a character is saying). CAPTION2 displays foreign language closed captions (foreign language words showing what a character is saying).

TEXT1 and TEXT2 display half-screen text (such as a channel guide, schedule or announcement).

OFF turns off closed captions. Captions will not appear on the screen.

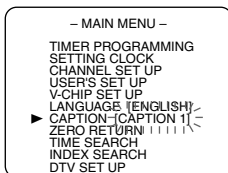

DTV SET UP will show only in DTV Mode.

- 3 Press SET-UP to exit the menu.**

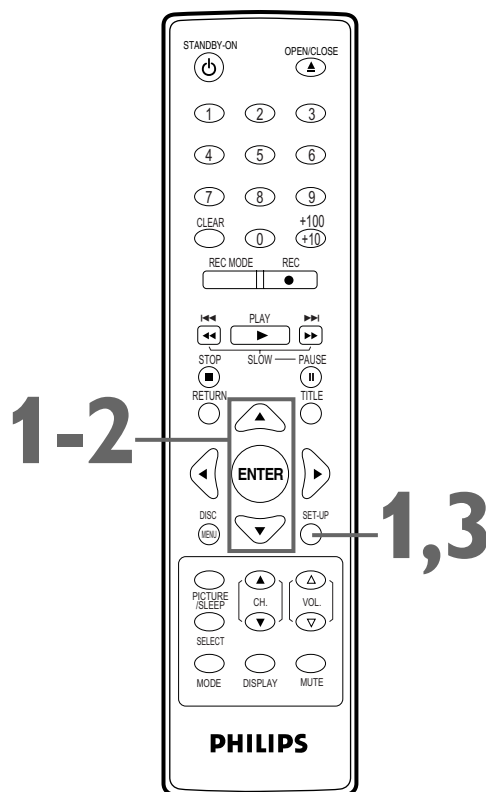

Helpful Hints

- If a black box appears on the screen that means a TEXT mode is selected. In this case, select CAPTION1, CAPTION2 or OFF to remove the black box.
- The TV/VCR/DVD retains the Closed Caption setting if the power fails.
- Abbreviations, symbols and other grammatical shortcuts may be used in order to keep pace with the on-screen action. This is not a problem with the TV/VCR/DVD.
- Changing channels may delay closed captions for a few seconds.
- Adjusting or muting the volume may delay closed captions for a few seconds.

Closed Captions (DTV) 45

DTV

- 1** Press **SET-UP**.
- 2** Press **▲** or **▼** to select **DTV SET UP**. Then, press **ENTER**.

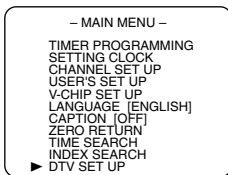

DTV SET UP will show only in DTV Mode.

- 3** Press **▲** or **▼** to select **DTVCC**. Then, press **ENTER**.

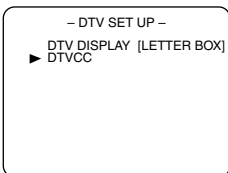

- 4** Press **▲** or **▼** to select an item.

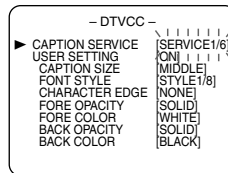

Referring to the explanations below, change the setting as you prefer by pressing **ENTER**.

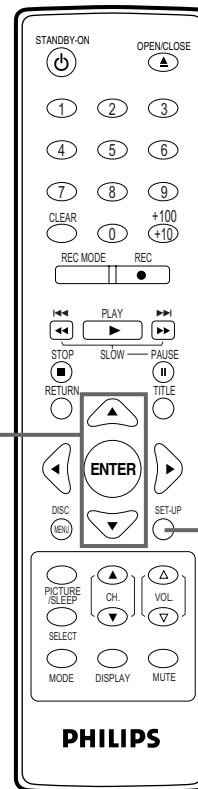

Caption Service

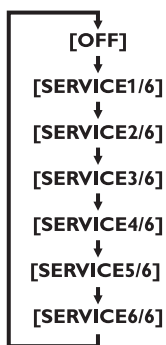

- Available Caption Services differ depending on the broadcast description.

Instructions continue on the next page.

TV/VCR/DTV

46 Closed Captions (DTV) (cont'd)

Instructions continued from the previous page.

User Setting

The USER SETTING function lets you change the caption size and font style.



5 When USER SETTING is set to ON, you can set the following items.

- DTVCC -	
CAPTION SERVICE	[SERVICE1/6]
USER SETTING	[ON1/1/2]
CAPTION SIZE	[MIDDLE1]
FONT STYLE	[STYLE1/8]
CHARACTER EDGE	[NONE]
FORE OPACITY	[SOLID]
FORE COLOR	[WHITE]
BACK OPACITY	[SOLID]
BACK COLOR	[BLACK]

Referring to the explanations below, change the setting as you prefer by pressing ENTER.

[CAPTION SIZE]

Text size of the displayed caption can be switched as below.

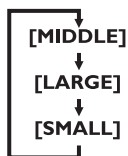

[FONT STYLE]

Font style of the displayed caption can be switched as below.

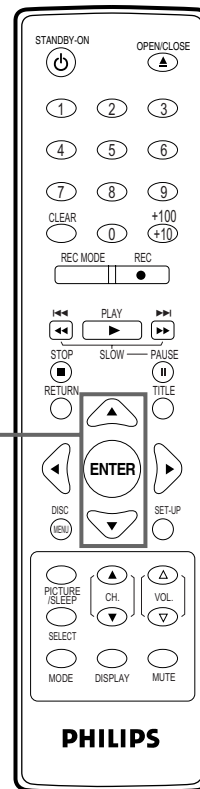
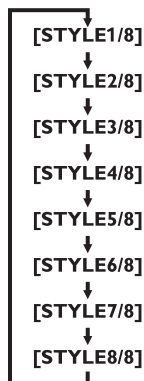

Closed Captions (DTV) (cont'd) 47

[CHARACTER EDGE]

Text edging of the displayed caption can be switched as below.

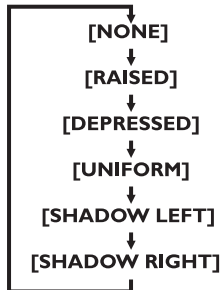

[FORE OPACITY]

Text opacity of the displayed caption can be switched as below.

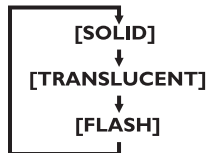

[FORE COLOR]

Text color of the displayed caption can be switched as below.

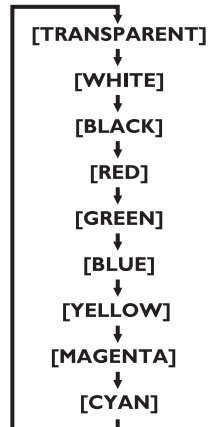

[BACK OPACITY]

Background opacity of the displayed caption can be switched as below.

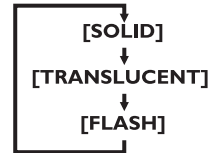

[BACK COLOR]

Background color of the displayed caption can be switched as below.

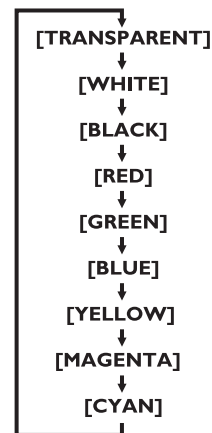

TV/VCR/DTV

48 Setting V-Chip

TV Rating Settings

V-CHIP enables parents to prevent their children from watching inappropriate material on TV. V-CHIP reads the ratings for programming (except for news and sports programs, unedited movies on premium cable channels, and Emergency Broadcast System signals), then denies access to programming if the program's rating meets the limitations you select. In this case, a "PROTECTED PROGRAM by ..." message appears on the TV screen.

If the "PROTECTED..." message appears during your TV viewing, change to a channel that is not blocked. Then, you can access the V-Chip Setup menu and change the settings to allow all TV viewing.

Programming may be rated by the Motion Picture Association of America (MPAA) or according to the Television Parental Guidelines. To block any inappropriate programming, set your limits in both MPAA RATING and TV RATING.

Before you begin, make sure ...

- The TV/VCR/DVD is on.
- The unit is in TV/VCR mode. Press SELECT on the remote until you see TV channels and see the red VCR/TV light on the front of the TV/VCR/DVD.

1 Press SET-UP. Press ▲ or ▼ to select V-CHIP SET UP. Then, press ENTER.

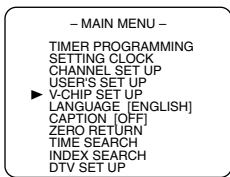

DTV SET UP will show only in DTV Mode.

2 Press the Number buttons to enter the 4-digit access code. When entering the access code for the first time or if there has been a power failure, enter default code 0000. 4 Xs will appear instead of your code. This protects the identity of your code.

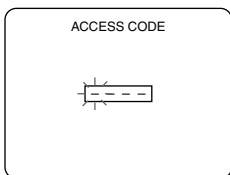

3 Press ▲ or ▼ to select TV RATING. Then, press ENTER.

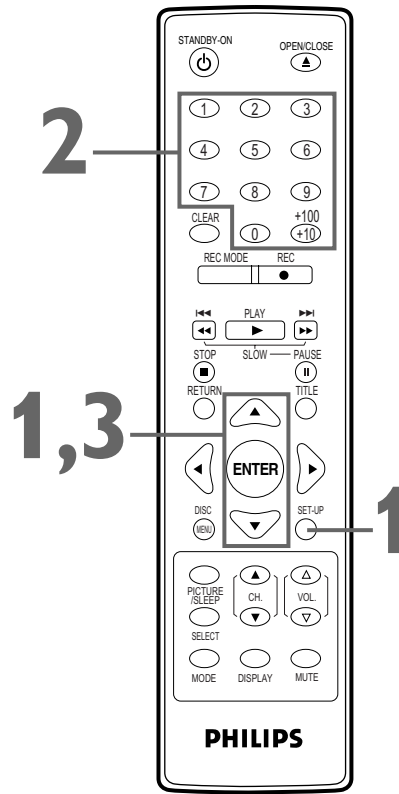
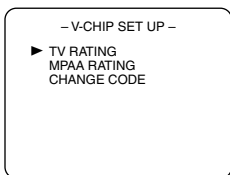

TV Rating Explanations

- TV-Y - Appropriate for all children
- TV-Y7 - Appropriate for children seven and older
- TV-G - General Audience
- TV-PG - Parental Guidance suggested
- TV-14 - Unsuitable for children under 14
- TV-MA - Mature audience only

Setting V-Chip (cont'd) 49

- 4** Press **▲** or **▼** to select the TV Rating level at which you want to block viewing, then press **ENTER** once. If you press ENTER again, the subratings for that category will appear. Details are on pages 50-51.

When you select the rating category and set it to **BLOCK**, the higher ratings will turn to **BLOCK** automatically. Lower ratings will turn to **VIEW**. When you set "TV-Y" to **VIEW** (or **BLOCK**), all ratings will turn to **VIEW** (or **BLOCK**) automatically.

TV-Y	()	[VIEW]
TV-Y7	()	[VIEW]
TV-G	()	[BLOCK]
TV-PG	()	[BLOCK]
TV-14	()	[BLOCK]
TV-MA	()	[BLOCK]

- 5** Press **SET-UP** to save your settings and remove the menus.

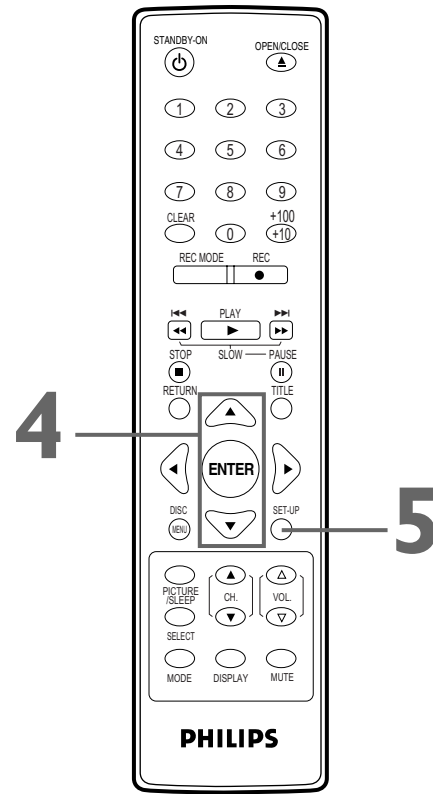

Helpful Hints

- If you want to disable V-Chip so you can view all TV programming, set TV-Y to VIEW.
- The V-CHIP settings will be retained after a power failure (except the access code reverts to 0000).

TV/VCR/DTV

50 Setting V-Chip (cont'd)

TV Rating Subratings

When you select TV-Y7, TV-PG, TV-14 or TV-MA, you can use the subratings to block specific elements of programming, such as language or violence.

1 Press SET-UP.

2 Press ▲ or ▼ to select V-CHIP SET UP. Press ENTER.

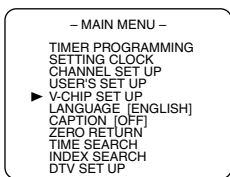

DTV SET UP will show only in DTV Mode.

3 Press the Number buttons to enter the 4-digit access code. The default code is 0000 (if you have not set up your own code yet or if there has been a power failure).

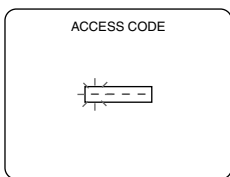

4 Press ▲ or ▼ to select TV RATING. Press ENTER.

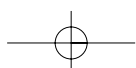
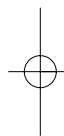
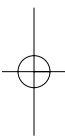
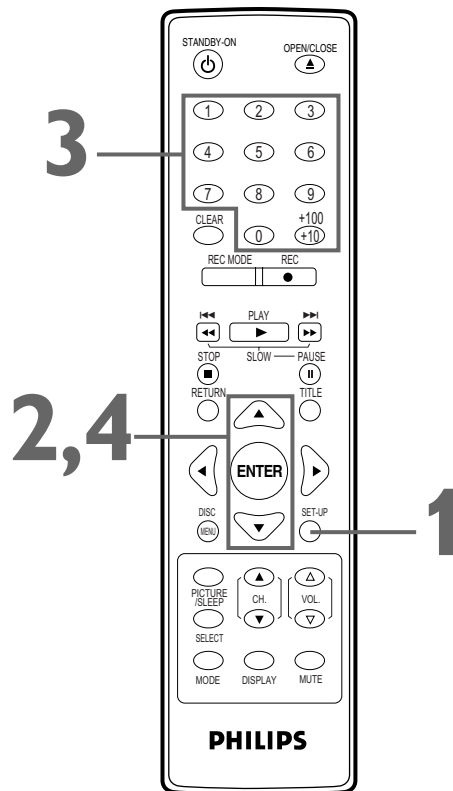
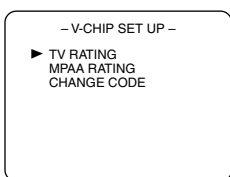

Setting V-Chip (cont'd) 51

- 5** Press **▲** or **▼** to select the rating you wish to adjust. Then, press **ENTER** twice to go to its subratings.

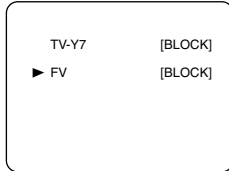

Example:
TV-Y7 subratings

- **When you select TV-Y7:**
Press **▲** or **▼** to select FV (Fantasy Violence, violence that seems realistic to young children). Then, press **ENTER** to select **BLOCK** or **VIEW**.
- **When you select TV-PG, TV-14 or TV-MA:**
Press **▲** or **▼** to select "D" (Suggestive Dialog), "L" (Coarse Language), "S" (Sexual Situation) or "V" (Violence). Then, press **ENTER** repeatedly to select **BLOCK** or **VIEW** for each subrating. To go to the previous menu, press **RETURN**.

- 6** Press **SET-UP** to save your settings and remove the menu.

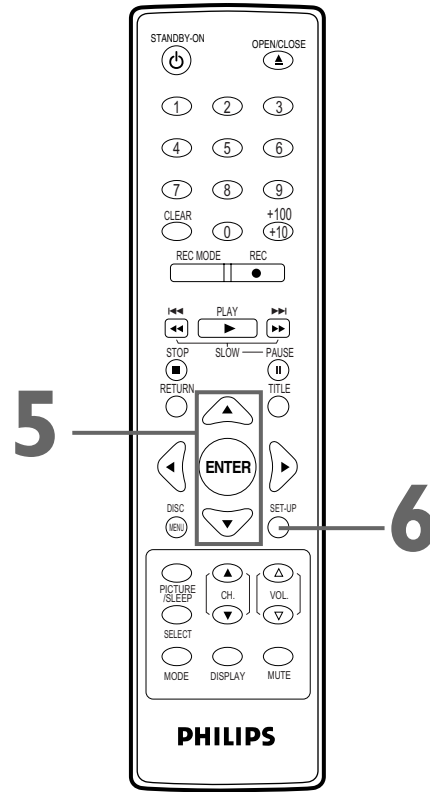

Helpful Hints

- Dialog (D) is not an available subrating for TV-MA.
- Blocked subratings will appear beside the rating category in the TV Ratings menu.
- You cannot **BLOCK** a subrating (D, L, S or V) if the main category is set to **VIEW**. However, you can set a subrating to **VIEW** even when the main category is set to **BLOCK**.
- Changing the category to **BLOCK** or **VIEW** automatically changes all its subratings to the same (**BLOCK** or **VIEW**).

TV/VCR/DTV

52 Setting V-Chip (cont'd)

MPAA Rating Settings

You can block TV channel viewing according to the Motion Picture of Association ratings. To do so, follow these steps.

1 Press SET-UP.

2 Press ▲ or ▼ to select V-CHIP SET UP. Then, press ENTER.

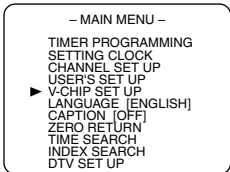

DTV SET UP will show only in DTV Mode.

3 Press the Number buttons to enter the 4-digit access code. (The default code is 0000 if you have not set up your own code yet or if the power has failed.)

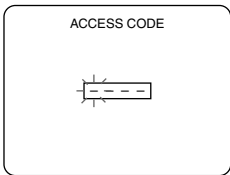

4 Press ▲ or ▼ to select MPAA RATING. Then, press ENTER.

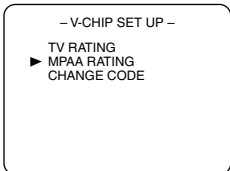

5 Press ▲ or ▼ to select the level at which you want to block viewing. Then, press ENTER to select BLOCK or VIEW.

When you Block a category, higher ratings turn to BLOCK automatically. Lower ratings turn to VIEW. When you set G to VIEW or BLOCK, all ratings turn to VIEW or BLOCK automatically.

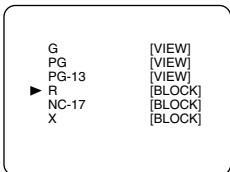

6 Press SET-UP to save your settings and remove the menu.

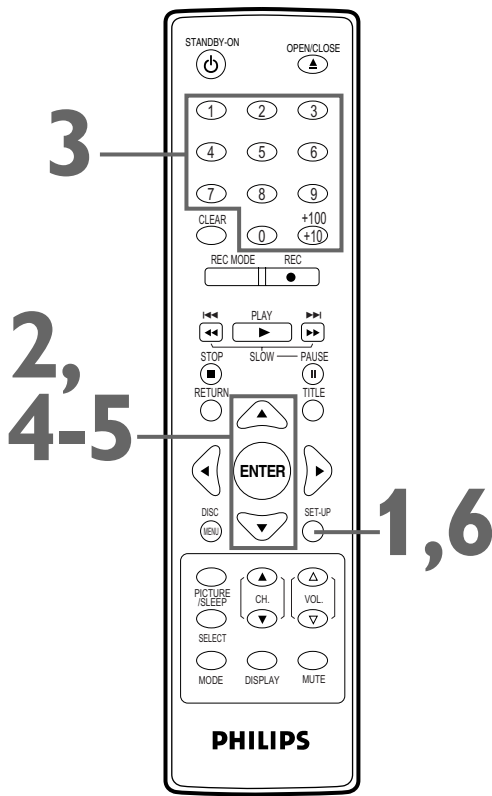

MPAA Rating Explanations

- G - General Audience
- PG - Parental Guidance suggested.
- PG-13 - Unsuitable for children under 13
- R - Restricted; under 17 requires accompanying parent or adult guardian
- NC-17 - No one under 17 admitted
- X - Mature audience only

Helpful Hints

- To disable all the MPAA Ratings, set G to VIEW.
- The V-CHIP settings will be retained after a power failure (except the access code reverts to 0000).

Setting V-Chip (cont'd) 53

Changing the Access Code

Although the default code 0000 is supplied with the TV/VCR/DVD, you can set your own access code.

- 1** Press **SET-UP**.
- 2** Press **▲** or **▼** to select **V-CHIP SET UP**. Then, press **ENTER**.
- 3** Press the **Number** buttons to enter the old access code. When doing this for the first time, use 0000. 4 Xs will appear instead of the code to protect its identity.

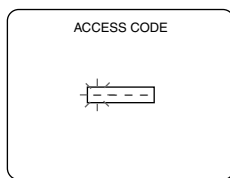

- 4** Press **▲** or **▼** to select **CHANGE CODE**. Then, press **ENTER**.

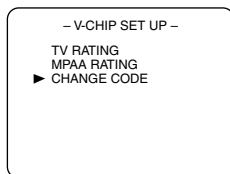

- 5** Press the **Number** buttons to enter your preferred access code in the **NEW CODE** space. Then, enter the same code in the **CONFIRM CODE** space. Again, Xs will appear instead of the code numbers. The access code must have exactly 4 digits.

The V-CHIP SET UP screen will reappear.

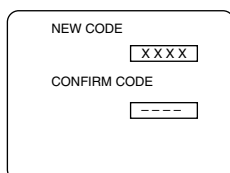

- 6** Press **SET-UP** to save your settings and remove the menus.

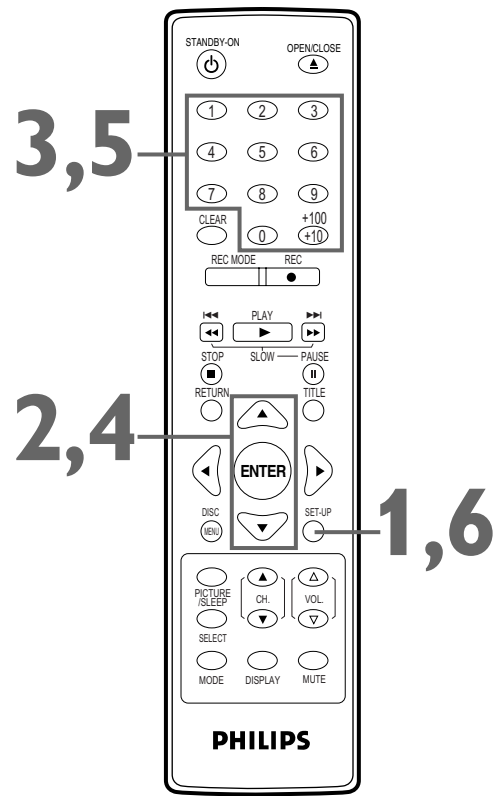

Helpful Hints

- If you enter the wrong code in the CONFIRM CODE space, repeat step 5. Enter the same new code exactly in the CONFIRM CODE space.
- If you unplug the power cord or if the power fails, the default code will be active again (0000). Change your access code again as necessary.

TV/VCR/DTV

54 Changing the Screen Display Mode (DTV)

DTV

2 types of display modes can be selected in the digital mode. You can select your favorite display mode and enjoy the program.

- Before you begin, press **SELECT** to put the TV/VCR/DVD in DTV mode.

- 1 Press **SET-UP**.
- 2 Using **▲** or **▼**, select **DTV SET UP**. Then, press **ENTER**.

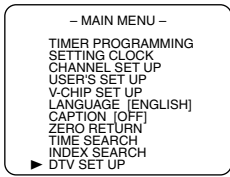

DTV SET UP will show only in DTV Mode.

- 3 Press **▲** or **▼** to select **DTV DISPLAY**.

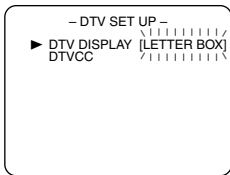

Press **ENTER** to switch between **LETTER BOX** and **ZOOM**.

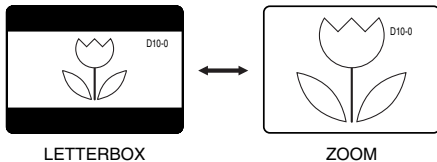

[LETTERBOX]
 Display the digital-supported program in full-screen. **Black borders will spread in the upper and lower screen.**

[ZOOM]
 Enlarge and display the center area of the digital-supported program. The right and left side of image will be cut off.

- 4 To exit the menu, press **SET-UP**.

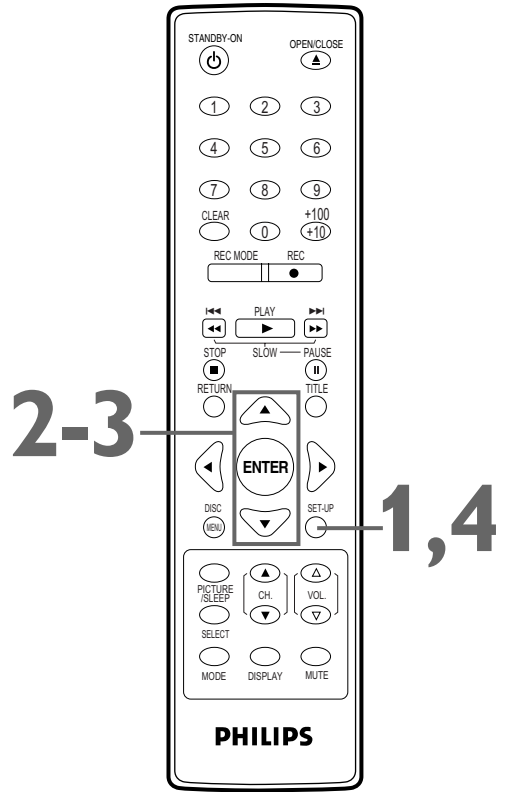

Helpful Hint

- You may not switch the display mode depending on the program.

Multi-Channel Television Sound (MTS) 55

You can set the TV/VCR/DVD to receive or record TV programs in Stereo, Second Audio or Monaural Sound. Also, you can set the TV/VCR/DVD to play videotapes in either High Fidelity (HIFI) or Monaural (MONO or single-channel) sound. See pages 56-57 on how to set the sound mode.

- 1 Press **DISPLAY** to see the sound status. During TV viewing, press DISPLAY twice. During tape playback, press DISPLAY once.

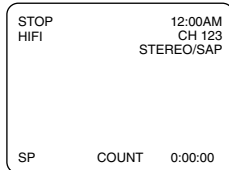

When a TV program is broadcast in stereo, STEREO appears in the top right corner of the screen. When a TV program is broadcast in second audio, SAP appears in the top right corner of the screen. When a TV program is broadcast both in stereo and second audio, STEREO and SAP both appear.

Although a program may be broadcast in both stereo and second audio, you cannot record in both stereo and second audio at the same time.

You must set the TV/VCR/DVD to record in either STEREO or SAP. Do this by changing the TV AUDIO setting as described on page 56.

During tape playback, HIFI will appear in the top left corner of the screen if VCR AUDIO is set to HIFI.

Details are on page 57. If you play non-HIFI tapes while VCR AUDIO is set to HIFI, HIFI will disappear from the screen. The videotape will play in monaural sound.

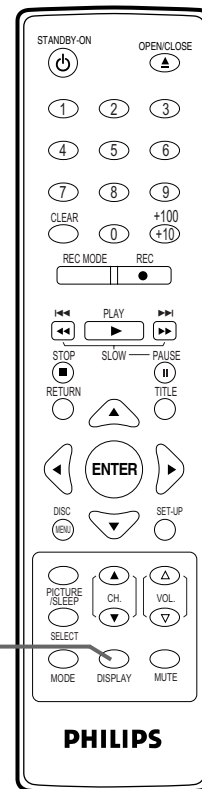

TV/VCR/DTV

56 Multi-Channel Television Sound (MTS) (cont'd)

For TV Audio

1 While receiving an MTS broadcast, press **MODE** repeatedly to select **STEREO**, **SAP** (Second Audio Program) or **MONO**.

- The mode changes according to the broadcast among STEREO, SAP and MONO every time you press the button.
- The current mode appears on the TV screen for about 5 seconds.

DTV

1 When you press **MODE** repeatedly, the currently selected language and the number of received languages will be displayed on the screen.

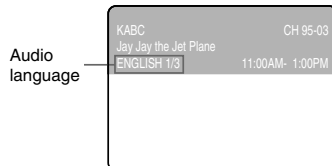

Every time you press **MODE**, the language will be switched.

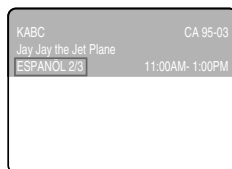

Languages you can switch differ depending on the receiving broadcast.

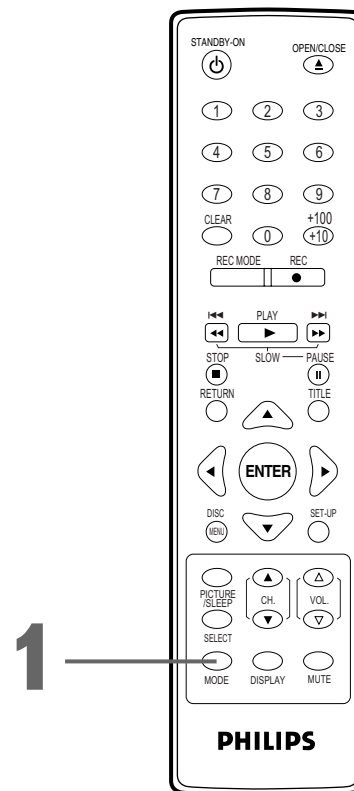

Helpful Hints

- The initial setting is STEREO.
- When recording a TV program, TV/VCR/DVD records MTS broadcasts in HIFI stereo sound automatically unless you select SAP mode recording beforehand.
- If you select second audio when second audio is not available, the TV/VCR/DVD will receive and record normal audio.
- Even if you press MODE in external input, the audio will not be switched.

Multi-Channel Television Sound (MTS) (cont'd) 57

For VCR Audio

1 During playback of a videotape, press **MODE** to switch **HIFI** or **MONO**.

- The current mode appears on the TV screen for about 5 seconds.
- The initial setting is HIFI.
- This setting is saved until the cassette is ejected.

For External Devices

- Pressing **MODE** does not affect the audio output mode of an external device.
- The current audio output mode of an external device does not appear on the TV screen.

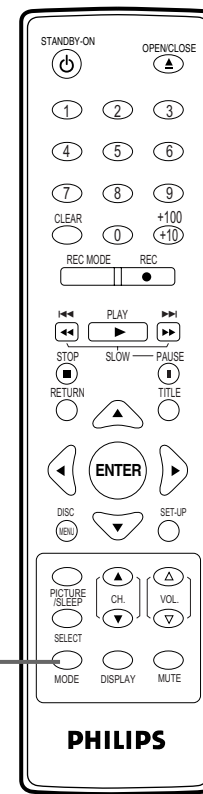

Helpful Hints

- Non-HIFI tapes will play in monaural automatically.
- When playing a non-HIFI tape, pressing **MODE** will only affect the display shown on the TV screen but it does not affect the actual sound mode.
- MTS broadcasts automatically record in HIFI unless you select SAP before recording. *Details are on page 56.*

DVD

58 DVD Disc Menus, Title Menus

Disc Menus

Some DVDs contain menus that describe the contents of the disc or allow you to customize disc playback. For example, the menu may offer choices for subtitle languages, special features or scene selection.

To use the DVD Disc menu and select playback features, follow these steps.

- **Before you begin, press SELECT** to put the TV/VCR/DVD in DVD mode. The green DVD light will appear on the front of the TV/VCR/DVD.

1 Press DISC MENU.
The DVD's Disc menu will appear.

2 Press ▲, ▼, ◀ or ▶ to select an item, then press ENTER. Continue this process to set up all the features you want or to start disc playback.

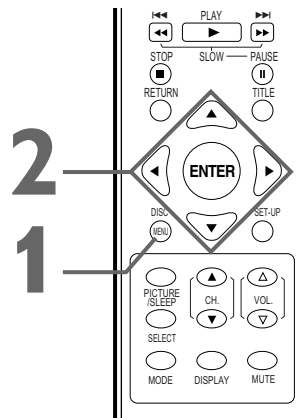

Title Menus

Some DVDs have a Title menu, which lists the titles available on the DVD. Use the Title menu to play a specific Title.

- **Before you begin, press SELECT** to put the TV/VCR/DVD in DVD mode. The green DVD light will appear on the front of the TV/VCR/DVD.

1 Press TITLE. The Title menu will appear.
If a Title menu is not available, the "X" may appear on the TV screen. Or, if the DVD only has a main menu as described above, it may appear when you press TITLE.

2 Press ▲, ▼, ◀ or ▶ to select a title, then press ENTER. Playback will begin at the title you selected.

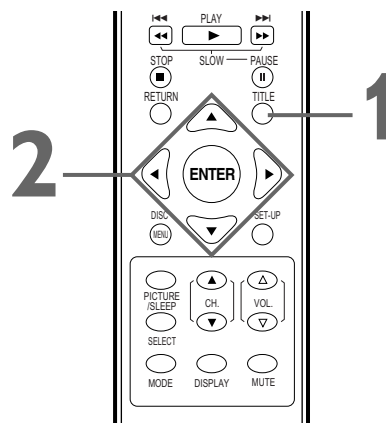

Playback Control (PBC) Function

When playing a Video CD with PBC (Playback Control), you can use interactive menu (e.g., playlists) on the TV screen.

Refer to instructions accompanying your Video CD for more details on PBC.

Some operations cannot be performed unless the PBC function is cancelled temporarily.

Canceling and calling back the PBC function

1 While playback is stopped, press the Number Buttons to enter a track number.
PBC function is now cancelled and the playback of the Video CD will start.

2 To call back the PBC function, press STOP ■ twice, then press PLAY ▶.
The Title menu will appear on the TV screen.

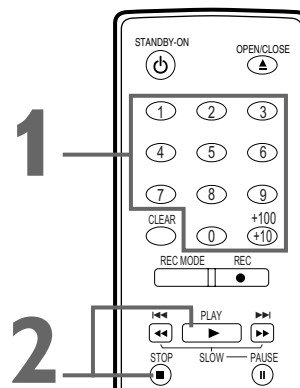

Helpful Hints

- Menus vary among discs. Follow the information with the DVD.
- Not all DVDs have Disc or Title menus.
- Some DVDs may refer to chapters as "scenes." Some DVDs may refer to the Title menu as the "scene index."
- TITLE may not be active with all DVDs.

DVD

Fast Forward/Fast Reverse 59



- **Before you begin, press SELECT** to put the TV/VCR/DVD in DVD mode. The green DVD light will appear on the front of the TV/VCR/DVD.

1 During playback, press and hold **⏮** or **⏭** on the remote control to fast forward or fast reverse the picture.

- For DVD playback, each time you press and hold the button, it will increase the speed by approximately 2, 8, 20, 50 or 100 times the normal speed. The speed may vary depending on the disc.

▶▶ 1, ▶▶ 2, ▶▶ 3, ▶▶ 4 or ▶▶ 5 will appear briefly on the TV screen to indicate forward searching. Or, ⏮ 1, ⏮ 2, ⏮ 3, ⏮ 4 or ⏮ 5 will indicate reverse searching.

For DVD playback, the sound will be mute during the search.

- For Video CDs, Audio CDs, MP3 or Windows Media™ Audio playback, the speed will increase by 2, 8 or 30 times the normal speed. The speed may vary depending on the disc.

▶▶ 1, ▶▶ 2 or ▶▶ 3 will appear briefly on the TV screen to indicate forward searching. Or, ⏮ 1, ⏮ 2 or ⏮ 3 will indicate reverse searching.

For Audio CD, MP3 or Windows Media™ Audio playback, the sound will be intermittent during the search.

For Video CD Playback, the sound will be mute during the search.



Example: Playing a DVD in reverse at twice the normal playing speed.

2 Press **▶** to return to normal playback.

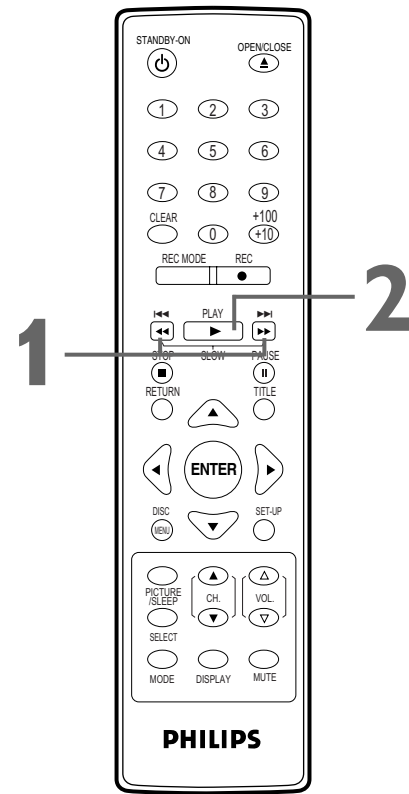

Helpful Hint

- If you use **⏮** or **⏭** during Dual Playback, JPEG playback will be paused.

DVD

60 Chapter/Title/Time Search

- **Before you begin, press SELECT** to put the TV/VCR/DVD in DVD mode. The green DVD light will appear on the front of the TV/VCR/DVD.

- 1 During disc playback, press MODE repeatedly** until the Search menu appears in the information bar at the top of the screen.

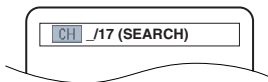

Then proceed to the step 2 of your desired search mode.

Chapter Search

- 2 Enter the chapter number you want to search in the input field in the information bar using the Number buttons.** The chapter will play.
 - To play a single-digit chapter when there are more than 10 sections, press ENTER after entering the chapter number.
 - If you enter the chapter number that is not available on the disc, playback will not begin (or the current chapter will continue to play).

Title Search

- 2 Press ▲ or ▼ repeatedly until TT appears.**

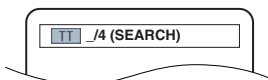

- 3 Enter the title number you want to search in the input field using the Number buttons.** The title will play.
 - To play a single-digit title when there are more than 10 selections, press ENTER after entering the title number.
 - If you enter the title number that is not available on the disc, playback will not begin (or the current title will continue to play).

Time Search

- 2 Press ▲ or ▼ repeatedly until  appears.**

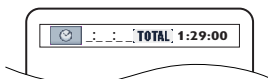

- 3 Within 1 minute, use the Number buttons to enter the elapsed playing time (of the track or title) at which you want play to begin.** Enter the time in hours, minutes and seconds. Within a few seconds, playback will start at the specified time.
 - Example: 1 hour, 23 minutes and 30 seconds
1 → 2 → 3 → 3 → 0
 - Make sure the time you enter is within the total time of the current title or track. If it is not, the time space will clear and playback will continue at its current point. The total time available in the current track or title will be displayed in the information bar.
 - If you make a mistake entering the time, press CLEAR to clear the time area. Enter the correct information.

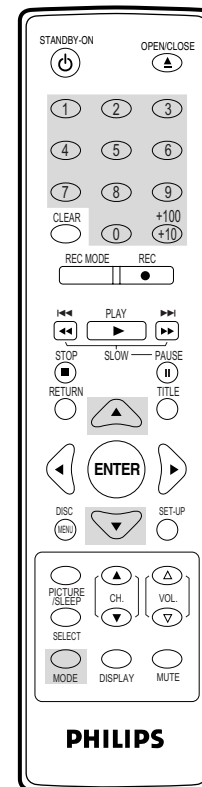

Helpful Hints

- While playback is stopped, use the Number buttons to select a title for immediate playback. During playback, use the Number buttons to choose a chapter for immediate playback.
- Title/Chapter Playback is not available with some DVDs.
- Time search is not available for MP3, Windows Media™ Audio and JPEG files.

Track Search 61

Track Search



There are three ways to search for a track. Refer to A-C below.

- **Before you begin, press SELECT** to put the TV/VCR/DVD in DVD mode. The green DVD light will appear on the front of the TV/VCR/DVD. Make sure a valid disc is in the disc tray.

A

Using the Number Buttons

To select a single digit track number: press the number directly. Playback of the selected track will start automatically.

To select 2 digit track number:

- If the disc contains more than 9 and less than 100 tracks (total track number is 2 digit), press +100/+10 button first. Then enter the track number. For example if you want to select track 26, press +100/+10 first, then press 2 and 6.
- If the disc contains more than 99 tracks (total track number is 3 digit), press +100/+10 button then press 0. Then enter the track number. Or press +100/+10 first, enter the track number, then press ENTER at the last.

To select 3 digit track number: Press +100/+10 first.

Then enter the track number.

If you enter a track number that is not available on the disc, playback will not begin (or the current track will continue to play).

B

Using **and**

During playback, press **to skip the current track and move to the next track.**

Press **to return to the beginning of the current track or to go to previous tracks.**

(For JPEG Playback, you also can use or .)

C

Using MODE

- 1 During disc playback, press MODE repeatedly** until the Search menu appears in the information bar at the top of the screen.

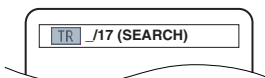

2

Press **or** **repeatedly until** **appears.** Within 1 minute, enter the desired track number using the Number buttons.

To select a single digit track number: Press 0 first. (If the total track number is more than 9 and less than 100, press 0 once. If the total track number is more than 99, press 0 twice.) Then enter the track number.

To select 2 digit track number:

- If the disc contains more than 9 and less than 100 tracks (total track number is 2 digit), enter the track number directly.
- If the disc contains more than 99 tracks (total track number is 3 digit), press 0 first. Then enter the track number. Or enter the track number, then press ENTER at the last.

To select 3 digit track number: Enter the track number directly.

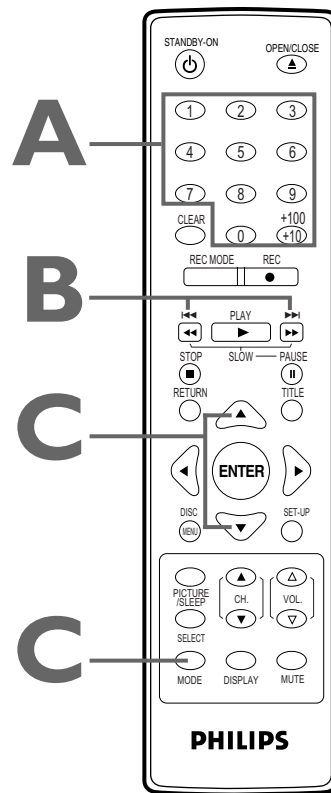

Helpful Hints

- do not function when playback is stopped.
- You cannot use to go from the last track on the disc to the first track.
- Using or during Dual Playback will only affect MP3 files. If you want to skip JPEG files during Dual Playback, press or .

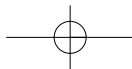

DVD

62 Paused and Step-by-Step Playback, Resume On

Paused Playback



Step-by-Step Playback



- Before you begin, press **SELECT** to put the TV/VCR/DVD in DVD mode. The green DVD light will appear on the front of the TV/VCR/DVD.

- 1 **During disc playback, press PAUSE II.** Playback will pause and the sound will be mute.
 - Pressing PAUSE II once during Dual Playback will pause a JPEG file only. Pressing PAUSE II one more time will pause an MP3 playback.

- 2 **Press PAUSE II repeatedly to see a DVD or Video CD picture advance one frame (or step) at a time.** The sound will remain mute. Pressing PAUSE II repeatedly during Audio CD, MP3, Windows Media™ Audio or JPEG playback will have no effect.

- 3 **Press PLAY ► to resume playback.**

Resume On



- Before you begin, press **SELECT** to put the TV/VCR/DVD in DVD mode. The green DVD light will appear on the front of the TV/VCR/DVD.

- 1 **Press STOP ■ during playback.** In a few seconds, the following Resume message will appear on the TV screen.

For DVD, VideoCD or AudioCD:

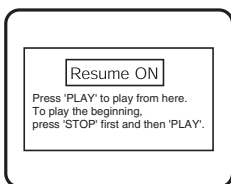

For MP3, Windows Media™ Audio or JPEG:

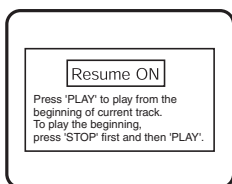

- 2 **Press PLAY ►.** In a few seconds, playback will resume from the point at which it stopped last. You can resume playing at the same point even if you turn off the TV/VCR/DVD, then turn it on again later. However, opening the disc tray will cancel the Resume feature. Playback will start at the beginning the next time you insert the disc. For MP3, Windows Media™ Audio and JPEG, the playback will resume from the beginning of the current track. To cancel the Resume feature, press STOP ■ again while playback is stopped. The resume information will be saved even when the power is turned off.

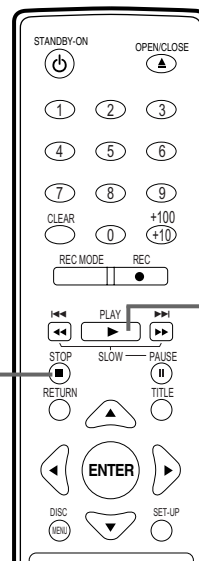
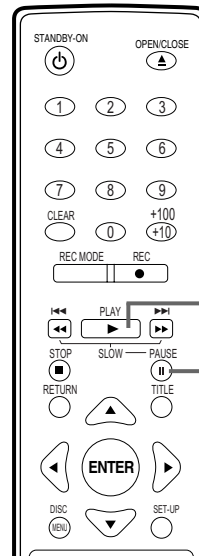

1

2

Helpful Hint

- Set STILL MODE to FIELD in the Display menu if paused images are blurry. Details are on pages 76-77.

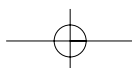
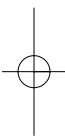

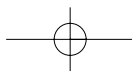

DVD

Repeat, A-B Repeat 63

Repeat

● Before you begin, press **SELECT** to put the TV/VCR/DVD in DVD mode. The green DVD light will appear on the front of the TV/VCR/DVD.

1 During disc playback, press **MODE** repeatedly until the Repeat menu appears in the information bar at the top of the screen.

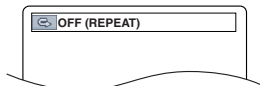

Press **▲** or **▼** repeatedly to change the repeat mode.

- Select CHAPTER, TITLE or OFF for DVDs.
- Select TRACK, ALL (all tracks on the disc) or OFF for VCDs without PBC function or Audio CDs.
- Select TRACK, GROUP (all tracks in the current folder), ALL or OFF for MP3, Windows Media™ Audio or JPEG files.

Selecting a new track, chapter or title will cancel Repeat Playback.

- During Programmed Playback, Repeat setting will be effective for the tracks in the program.

A-B Repeat

Follow these steps to play a section of a DVD, Video CD or Audio CD repeatedly.

1 During disc playback, press **MODE** repeatedly until the A-B Repeat menu appears in the information bar at the top of the screen.

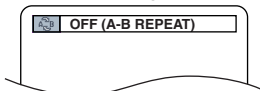

2 Play the disc up to the point where you want to set the start point, then press **ENTER** to set the starting point (A). If you make a mistake, press **CLEAR**. This will erase point A and let you start over. OFF will appear briefly on the TV screen.

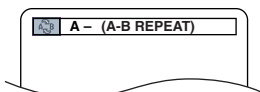

3 Play the disc up to the point where you want to set the end point, then press **ENTER** again. Within a few seconds, the section will begin to play. The segment will play over and over until you cancel the A-B Repeat feature.

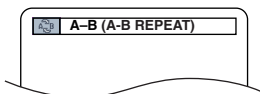

4 To cancel A-B Repeat Playback, press **MODE** repeatedly until A-B appears. Press **ENTER** so OFF appears on the TV screen. Regular playback will resume.

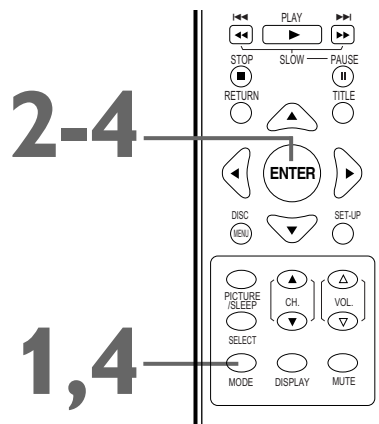
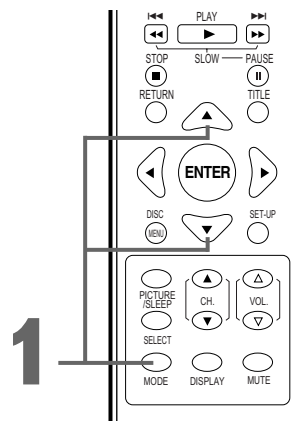

Helpful Hints

- Repeat and A-B Repeat are not available with some discs.
- A-B Repeat is not available with MP3, Windows Media™ Audio and JPEG playback.
- The entire A-B Repeat section must be within a single title or track. If you do not enter Point B before the end of the track or title is reached, the end of the track or title will become Point B automatically.
- Stopping playback will cancel A-B Repeat.
- If you choose GROUP Repeat during Dual Playback, all tracks or files in each folder will play repeatedly. For example if you choose GROUP Repeat during Dual Playback of MP3 folder A and JPEG folder B, all MP3 tracks in folder A and all JPEG files in folder B will be repeated.

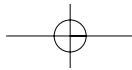
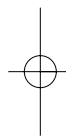
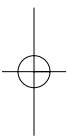



DVD

64 Markers

Marker Setting/Marker Search



You can put marks on your favorite playback points and can easily call them back later during playback.

- **Before you begin, press SELECT** to put the TV/VCR/DVD in DVD mode. The green DVD light will appear on the front of the TV/VCR/DVD.

- 1** During disc playback, press **MODE** repeatedly until the Search menu appears in the information bar at the top of the screen.



- 2** Press **▲** or **▼** repeatedly until the Marker information appears in the information bar.

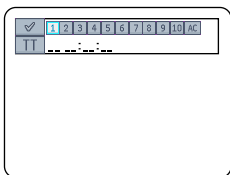

Example: DVD

- 3** Within 1 minute, press **◀** or **▶** to select a Marker (1-10). Make sure ____:__:__ appears beneath the number.

- 4** Let the disc playback to the point at which you want to set the Marker (up to 60 seconds away). When the disc reaches the point you want to remember, press **ENTER**. The title or track number and its elapsed playing time will appear beneath the markers. A checkmark will replace the Marker number. The Marker information will disappear in about 1 minute. Otherwise press **RETURN**.

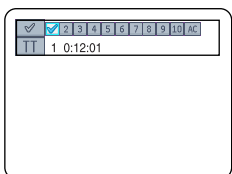

Example: DVD

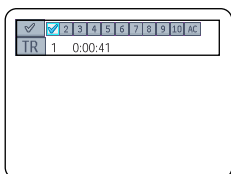

Example: VideoCD or Audio CD

- 5** To search for a specific Marker, repeat steps 1 and 2. Press **◀** or **▶** to choose the Marker you want. Press **ENTER**. The playback will start from the selected point.

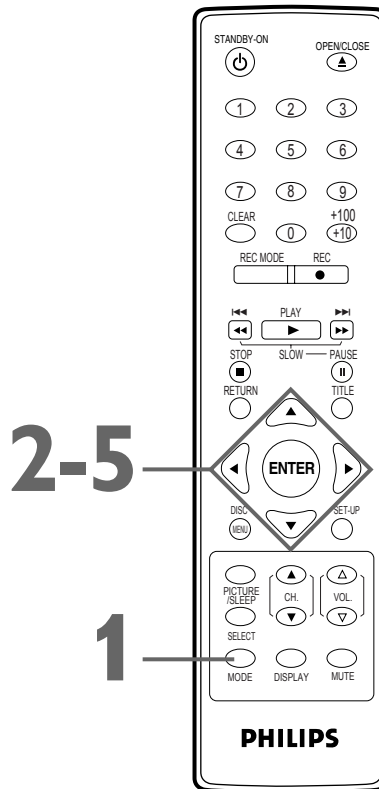

Helpful Hints

- Opening the disc tray, switching to TV/VCR mode, or turning off the TV/VCR/DVD will erase all the Markers.
- To erase a single Marker, repeat steps 1 and 2. Press **◀** or **▶** to select a Marker. Press **CLEAR**. Press **RETURN** to remove the information bar.
To erase all the Markers, select **AC (All Clear)**, then press **ENTER**.

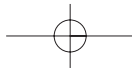

Subtitles, Camera Angles 65

Subtitles

You can select a language for DVD subtitles during playback. You may select only the subtitles that are available on the DVD.

- **Before you begin, press SELECT** to put the TV/VCR/DVD in DVD mode. The green DVD light will appear on the front of the TV/VCR/DVD.

- 1 During disc playback, press MODE repeatedly** until the Subtitle menu appears in the information bar at the top of the screen.

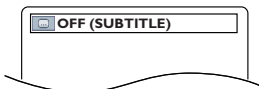

Press **▲** or **▼** repeatedly to change the language.

The number of available languages is displayed at the right of the current subtitle language. In the example below, six languages are available (/6). After a few seconds, the subtitles will appear.

When no subtitles are available, "NOT AVAILABLE" will appear in the information bar.

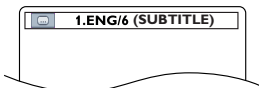

Example: English as first of six available subtitles

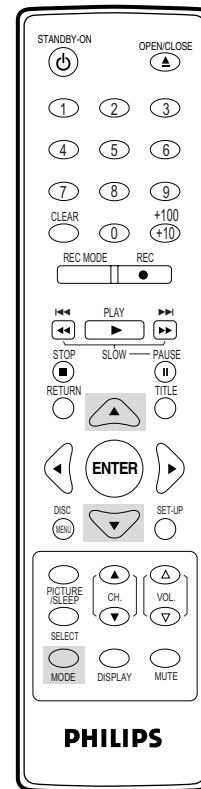

Camera Angles

Some DVDs contain scenes recorded from different angles. The camera angle will not change if the DVD does not contain sequences recorded from different perspectives.

- **Before you begin, press SELECT** to put the TV/VCR/DVD in DVD mode. The green DVD light will appear on the front of the TV/VCR/DVD.

- 1 During disc playback, press MODE repeatedly** until the Angle menu appears in the information bar at the top of the screen.

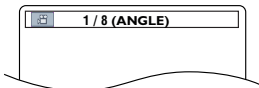

Press **▲** or **▼** repeatedly to change the angle.

The number of available angles are displayed at the right of the current angle. In this example, eight angles are available (/8).

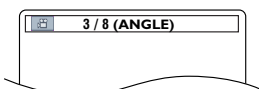

Example: Angle 3 of eight available angles

Helpful Hints

- With some DVDs, you must select a subtitle language in the Disc menu.
- If the desired language does not appear after pressing **▲** or **▼** several times, the disc does not have subtitles in that language.
- Opening the disc tray will cancel your subtitle setting.
- If the Angle Icon setting is on,  will appear on the TV screen when the current portion of the disc has multiple camera angles. To set the Angle Icon on or off, see pages 82-83.

DVD

66 Audio Language, Stereo Sound

Audio Language

You can select a language for DVDs during playback if multiple languages are available.

- **Before you begin, press SELECT** to put the TV/VCR/DVD in DVD mode. The green DVD light will appear on the front of the TV/VCR/DVD.

- 1 During disc playback, press MODE repeatedly until the Audio Language menu appears in the information bar at the top of the screen.**

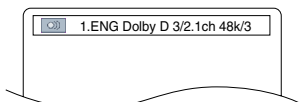

Example: English Audio

Press **▲** or **▼** repeatedly to change the language. The new audio will be heard. The information bar will disappear after about 1 minute. The Audio information may include the current settings for the Dolby Digital or Multi-channel sound, if they are available on the disc, and the sampling rate of the disc. The number of available languages are displayed at the right end of the information bar (/3, for example).

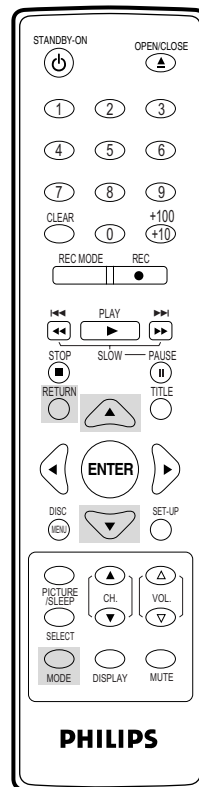

Stereo Sound

Adjust Stereo Sound to determine whether you will hear the left channel, the right channel or both channels (stereo) during Video CD or Audio CD playback.

- 1 During disc playback, press MODE repeatedly until the Stereo menu appears in the information bar at the top of the screen. Press ▲ or ▼ to change the stereo setting. The setting will change in the order illustrated below. The information bar will disappear in about 1 minute.**

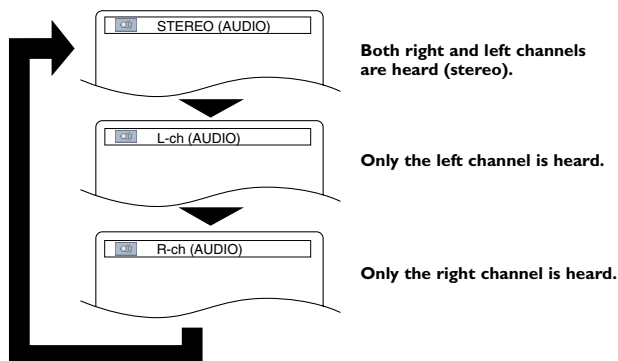

Press **RETURN** to remove the information bar.

Helpful Hints

- If a language is not available after pressing **▲** or **▼** several times, the DVD does not have that language.
- Some DVDs only let you change the language in the Disc menu.
- Audio languages may be abbreviated (such as ENG for English). Or, 3 dashes (- - -) may appear instead of an abbreviation.

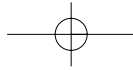

DVD

Slow Motion, Zoom 67

Slow Motion

- 1** Press **PAUSE** during DVD or Video CD playback.
- 2** Press and hold **◀◀◀/◀◀** or **▶▶▶/▶▶** for a few seconds. Slow Motion Playback will begin. Press **◀◀◀/◀◀** or **▶▶▶/▶▶** repeatedly to play the DVD forward or backward at approximately 1/16, 1/8 or 1/2 the normal speed. Reverse slow motion is not available on a Video CD.
An **▶▶ 1 (1/16)**, **▶▶ 2 (1/8)** or **▶▶ 3 (1/2)** will appear briefly on the TV screen to indicate Slow Forward Playback.
An **◀◀ 1 (1/16)**, **◀◀ 2 (1/8)** or **◀◀ 3 (1/2)** will indicate Slow Reverse Playback.



Example: Playing a DVD forward at half the normal speed.

- 3** Press **PLAY** to return to normal playback.

Zoom

Zooming lets you enlarge the playback image of DVDs, Video CDs or JPEG CDs, and lets you pan through the enlarged image.

- 1** During disc playback, press **MODE** repeatedly until **OFF (ZOOM)** appears in the information bar at the top of the screen.
- 2** Press **ENTER** repeatedly to change the zoom factor. Each press of **ENTER** will change the factor as shown below.

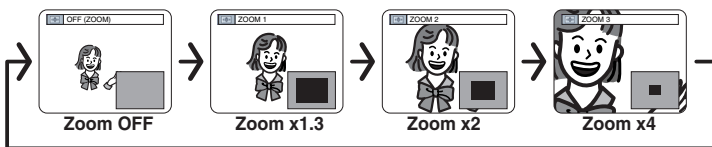

- 3** Press **▲**, **▼**, **◀** or **▶** to move the zoomed image up, down, left or right.

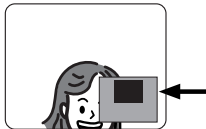

Position guide example:
The Zoomed area is in the top portion of the overall picture.

- Available zoom factor for each media.

For DVDs:	x1.3 zoom (ZOOM 1)
	x2 zoom (ZOOM 2)
	x4 zoom (ZOOM 3)
For Video CDs:	x1.3 zoom (ZOOM 1)
	x2 zoom (ZOOM 2)
For JPEG files:	x2 zoom (ZOOM 1)

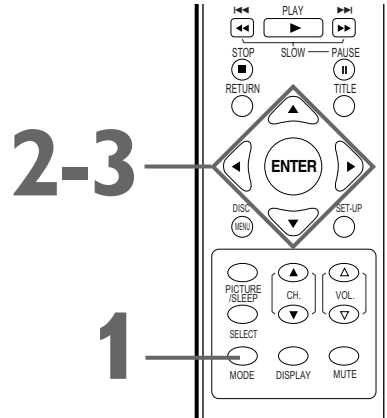
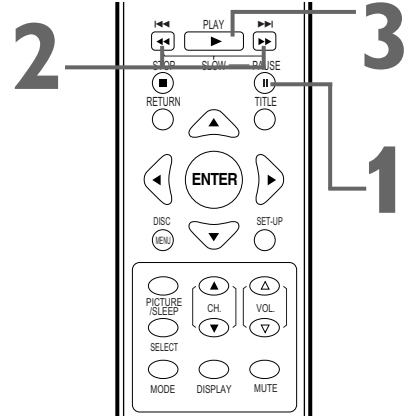

Helpful Hints

- The sound will be mute during Slow Motion Playback.
- The gray box with an inner blue box that shows during Zoomed Playback is the position guide. Position guide stays on the screen while the information bar is shown. To remove it or show it, press **ENTER** after the information bar disappears. Or remove the information bar by pressing **RETURN**, then press **ENTER**. The position of the blue box inside the gray box indicates the position of the zoomed image within the overall picture.
- The x4 zooming is not active with some discs. x1.3 and x2 zooming is available for Video CDs. Only x2 zooming is available for JPEGs.
- Position guide is not available for JPEG playback.

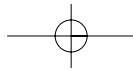

DVD

68 Random Playback, Program Playback

Random Playback

You may play the tracks / files in Random order instead of the order in which they are recorded (1, 2, 3...).

- Before you begin, press **SELECT** to put the TV/VCR/DVD in DVD mode. The green DVD light will appear on the front of the TV/VCR/DVD.

1 While playback is stopped, press **MODE** repeatedly until the **RANDOM** screen appears.

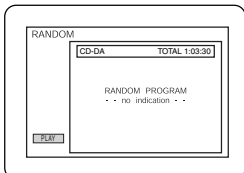

Example: Audio CD

2 Press **PLAY** . The tracks will play in random order. After all the tracks have played once, playback will stop.

Program Playback

You may determine the order in which the tracks / files will play. To set a program, follow these steps.

- Before you begin, press **SELECT** to put the TV/VCR/DVD in DVD mode. The green DVD light will appear on the front of the TV/VCR/DVD.

1 While playback is stopped, press **MODE** repeatedly until the **PROGRAM** screen appears.

2 Press **▲** or **▼** to select a track you want to play, then press **ENTER**.

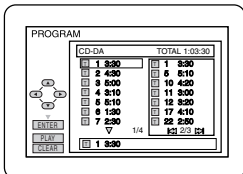

Example: Audio CD

Press **CLEAR** to erase the last track in the program if you make an error.

Additional tracks may be on other screens. press **▼** to go on to the next page, and press **▲** to go back to the previous page.

Repeat this step until you have selected all the tracks you wish to play in the program.

To see tracks in a program when there are more than eight tracks, use **◀◀/◀◀** and **▶▶/▶▶** to see all the tracks.

For MP3, Windows Media™ Audio or JPEG folders, press **◀** or **▶** to go to the previous or next level of folders. Press **TITLE** to return to the first item in the highest level.

3 Press **PLAY** . The tracks will play once in the order you set. Turning off the TV/VCR/DVD or opening the disc tray will erase the program. You can start Program Playback only while in the **PROGRAM** screen.

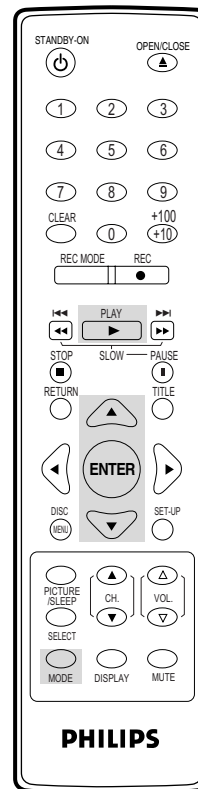

Helpful Hints

- You cannot use the Number buttons to select another track while playing a program. Press **◀◀/◀◀** or **▶▶/▶▶** to select other tracks in the program.
- You cannot combine Random Playback with Programmed Playback.
- You cannot alter a program during playback.
- You can start Program Playback only while in the **PROGRAM** screen.
- A program can have a maximum of 99 tracks.
- To erase all tracks in the program, select **ALL CLEAR** at step 2.
- Program/Random Playback of MP3, Windows Media™ Audio or JPEG tracks is not available while Dual Playback is on.

MP3/Windows Media™ Audio/JPEG Playback 69

The DVD player will play MP3, Windows Media™ Audio and JPEG files that you record and finalize on a CD-R (Compact Disc-Recordable) or CD-RW (Compact Disc-Rewritable).

- You cannot make or record such discs using this unit. See your computer manual for details on making or recording such discs. Keep the characteristics listed below in mind when making discs.
- Record MP3 files at a sampling frequency of 44.1 kHz or 48 kHz. Record in a constant bit rate between 32 kbps and 320 kbps.
- Record Windows Media™ Audio files at a sampling frequency of 44.1 kHz or 48 kHz. Record in a constant bit rate between 48 kbps and 192 kbps.
- When recording JPEG files, the size of the picture should be between 32 x 32 and 6300 x 5100 dots.



To play the files from the file list follow the steps below.

- **Before you begin, press SELECT** to put the TV/VCR/DVD in DVD mode. The green DVD light will appear on the front of the TV/VCR/DVD.

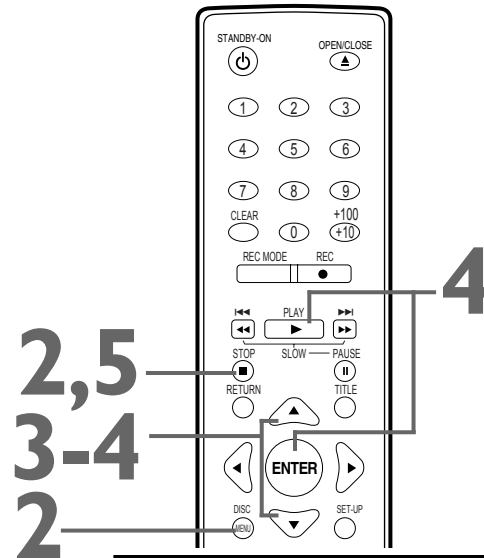
- 1 Load a CD-R or CD-RW with MP3, Windows Media™ Audio or JPEG files. The first file in the file list will start to play automatically.
- 2 Press **DISC MENU** to call up the file list during playback. Or press **STOP** ■ twice to stop the playback. (File list will appear whenever the playback is stopped completely.)
- 3 Press **▲** or **▼** to select a folder or a file.
- 4 If you choose a track or file, press **PLAY** ► or **ENTER**. Starting with the track or file you selected, the tracks/files will play in the order they were recorded, i.e. 1, 2, 3.
If you select a folder and press **ENTER**, the tracks or files within that folder will appear. Press **▲** or **▼** to select the track or file you want, then press **PLAY** ► or **ENTER**.
 - Press **TITLE** to return to the first item in the highest level of folders or files.
 - Press **◀** or **▶** to return to previous or next levels.
 - To change the TRANSITION MODE of JPEG playback, press **MODE** repeatedly during playback until **FADE IN/OUT** or **CUT IN/OUT** appears. Then press **▲** or **▼** to switch **CUT IN/OUT** and **FADE IN/OUT**. If you choose **CUT IN/OUT**, the images will cut in and out sharply as playback progresses. If you choose **FADE IN/OUT**, the images will fade in and out as playback progresses.
 - To change the size of the playback image, press **MODE** repeatedly until **SIZE** appears at the top of the TV screen during playback. Then press **ENTER** to switch between **NORMAL(100%)** and **SMALL(95%)**.
 - To remove the On-Screen Display, press **RETURN**.
 - During JPEG playback, press **▲** or **▼** to rotate a picture 90 degrees counter-clockwise or clockwise.
- 5 To stop playback, press **STOP** ■.



Helpful Hints

- MP3 tracks, Windows Media™ Audio tracks and JPEG images are known as files. Groups of files are called folders.
- Folders have the  icon.
- MP3 files have the  icon.
- JPEG files have the  icon.
- A maximum of 255 folders can be recognized. A maximum of 999 files can be recognized.
- During playback, press the Number buttons to select another track. Or, press **◀◀** or **▶▶** to change tracks. If a track is not available, "X" may appear on the TV screen, and playback may resume at an incorrect track or may continue with its current track.
- Specific Time Playback is not possible with MP3 and Windows Media™ Audio files.
- Progressive JPEGs (JPEG files saved in the progressive format) will not play on this TV/VCR/DVD.
- Copyright protected Windows Media™ Audio files will not play on this TV/VCR/DVD.
- High resolution JPEG files takes longer to be displayed.
- **SIZE CHANGE MODE** may have no effect on some files (e.g. files with a small picture size).

DVD

70 Dual Playback, Folder Playback

Dual Playback

This feature lets you play MP3 and JPEG files simultaneously. Available only when Dual Playback is on. See pages 82-83 on how to set the Dual Playback on or off.

- 1** Press **SELECT** to put the DVD/VCR in DVD mode. DVD light will appear on the front of the DVD/VCR.
- 2** Press **DISC MENU** during MP3 (or JPEG) playback. A File List will appear.
- 3** Press **▲** or **▼** to select a desired JPEG (or MP3) file you want to play simultaneously from the List. Then press **PLAY ►** or **ENTER**. Dual playback will start.
- 4** To stop playback, press **STOP ■**.

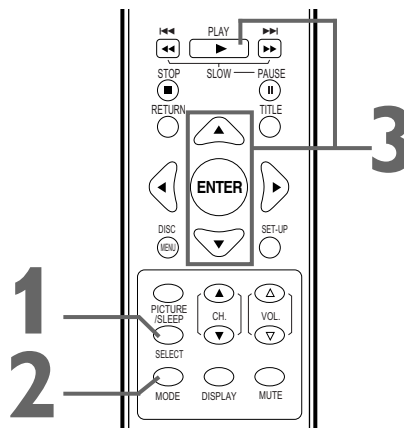
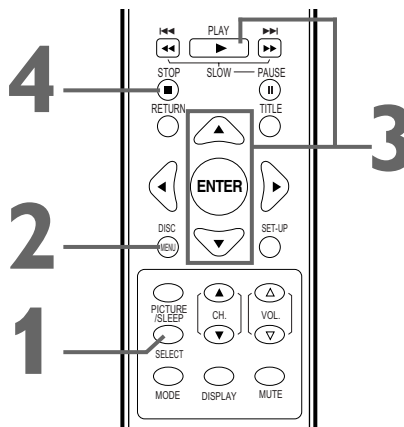

Folder Playback

You may select to play a folder. Available only when Dual Playback is on. See pages 82-83 on how to set the Dual Playback on or off.

- 1** Press **SELECT** to put the DVD/VCR in DVD mode. DVD light will appear on the front of the DVD/VCR.
- 2** While playback is stopped, press **MODE**. A Folder List will appear.
- 3** Press **▲** or **▼** to select a folder, then press **PLAY ►** or **ENTER**.
 - MP3 and JPEG files in the selected folder will play simultaneously.

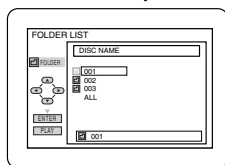

- If Windows Media™ Audio files are in the folder, those files will be skipped during Folder Playback.

Helpful Hints

- If you press **PLAY ►** directly after you inserted a disc which contains both MP3 and JPEG files and if the Dual Playback setting is on, Dual Playback will start automatically.
- If you play only MP3 file while Dual Playback Setting on, you will have a black background. This is not a malfunction.
- You can not play Windows Media™ Audio and JPEG files together at the same time. If you choose a Windows Media™ Audio file during Dual Playback, only Windows Media™ Audio file will play.
- Zooming or rotating a JPEG file during Dual Playback may cause an intermittent sound.
- Dual Playback may not function properly if MP3 and JPEG files on the disc interfere each other due to the difference in their data size.

DVD

On-Screen Displays 71

DVD Display

- Before you begin, press **SELECT** to put the TV/VCR/DVD in DVD mode. The green DVD light will appear on the front of the TV/VCR/DVD.

1 Press **DISPLAY** repeatedly to show the following information on the screen during DVD playback.

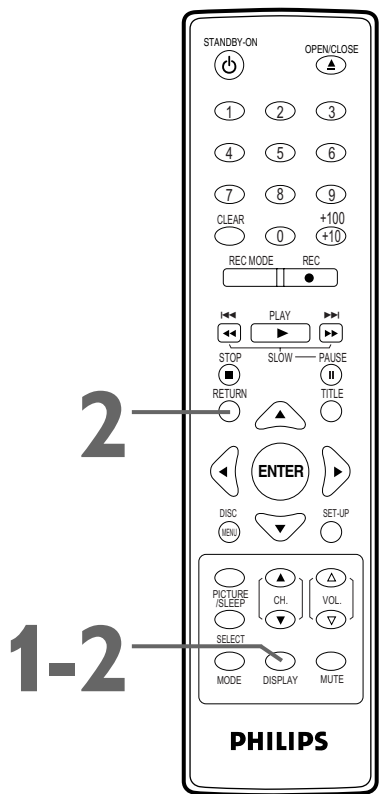
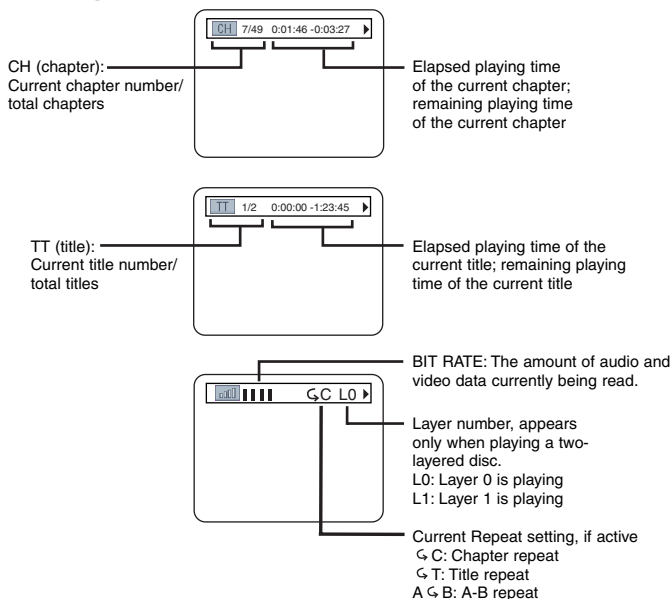

2 Press **DISPLAY** repeatedly or press **RETURN** to remove the information from the screen.

Video CD and Audio CD Display

- Before you begin, press **SELECT** to put the TV/VCR/DVD in DVD mode. The green DVD light will appear on the front of the TV/VCR/DVD.

1 Press **DISPLAY** repeatedly to show the following information on the screen during Video CD (without PBC) or Audio CD playback.

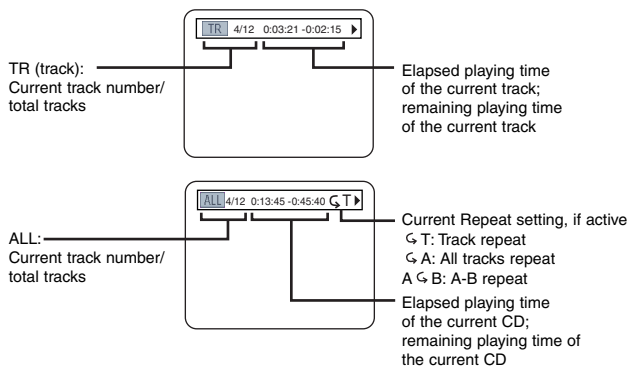

2 Press **DISPLAY** repeatedly or press **RETURN** to remove the information from the screen.

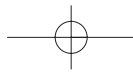

DVD

72 On-Screen Displays (cont'd)

MP3/Windows Media™ Audio/JPEG Displays

- Before you begin, press **SELECT** to put the TV/VCR/DVD in DVD mode. The green DVD light will appear on the front of the TV/VCR/DVD.

1 Press **DISPLAY** until the current track or file information appears.

During JPEG playback

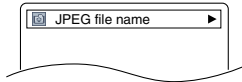

or

During MP3 playback

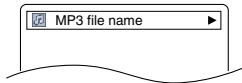

During Windows Media™ Audio playback

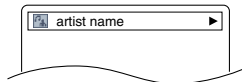
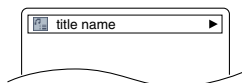
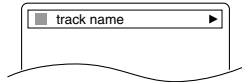

- If Dual Playback is on, MP3 file name will be displayed after JPEG file name.

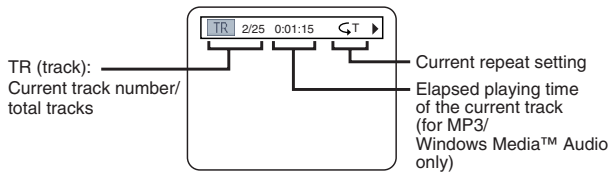

Example: MP3 playback

The following may appear to indicate Repeat Playback.

- T: The current track will play repeatedly.
- G: Tracks in the current folder (group) will play repeatedly.
- A: All tracks will play repeatedly.

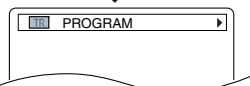

only during **PROGRAM** Playback
OR

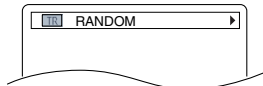

only during **RANDOM** Playback
OR



only during **FOLDER** Playback

- Program and Random Playback is available only when Dual Playback is off.
- Folder Playback is available only when Dual Playback is on.

2 Press **DISPLAY** again to remove the display.

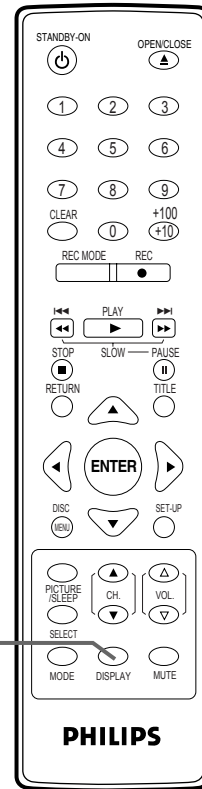

1-2

Helpful Hint

- For MP3/Windows Media™ Audio files recorded in Variable Bit Rate (VBR), the elapsed time displayed on the screen may vary from the actual elapsed time.

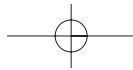

DVD

Black Level, Virtual Surround, Initializing 73

Black Level

Adjust Black Level to brighten the DVD and Video CD picture during playback.

- 1 During disc playback, press **MODE** repeatedly until the Black Level menu appears in the information bar at the top of the screen.



- 2 Within 1 minute, press **▲** or **▼** to switch **ON** or **OFF**. **ON** brightens the dark parts of the picture. **OFF** shows the original picture as recorded.

Virtual Surround



You can enjoy improved stereo sound when you play DVDs, Video CDs, Audio CDs, MP3 or Windows Media™ Audio files recorded in Dolby Digital or Pulse Code Modulation (PCM). Check the disc case for details on availability.

- 1 During disc playback, press **MODE** repeatedly until the Virtual Surround menu appears in the information bar at the top of the screen.

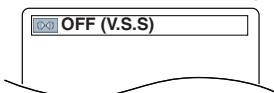

- 2 While the information bar is on the screen, press **▲** or **▼** to choose **1 (Natural)**, **2 (Emphasized)** or **OFF**. The default setting is **OFF**. The information bar will disappear after about 1 minute.

Initializing

You can return all the DVD player's Setup menu items (except for PARENTAL) to their default settings.

- Before you begin, press **SELECT** to put the TV/VCR/DVD in DVD mode. The green DVD light will appear on the front of the unit.

- 1 While playback is stopped, press **SET-UP** twice. The QUICK SETUP screen appears.

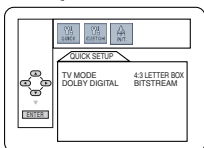

- 2 Press **◀** or **▶** to select **INIT. (INITIALIZE)** at the top of the menu, then press **ENTER**.

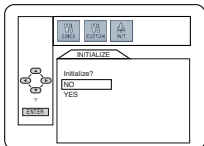

- 3 Press **▲** or **▼** to select **YES**. Then, press **ENTER** twice. To cancel, select **NO** instead.

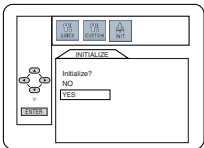

- 4 Press **SET-UP** to remove the menu.

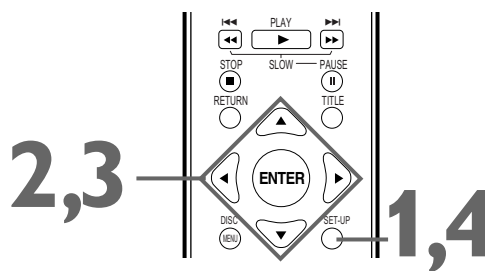
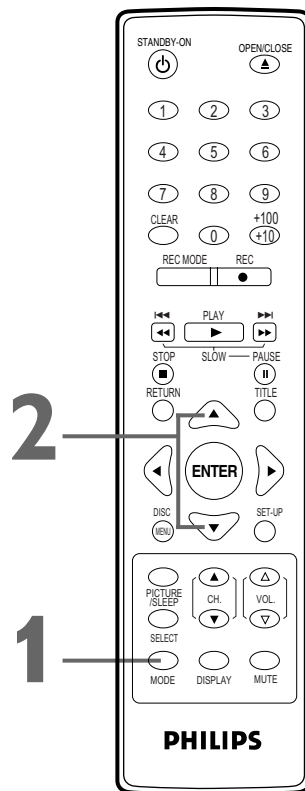

Helpful Hints

- For Video CDs and Audio CDs, you can adjust Virtual Surround only if you set Stereo Sound to STEREO. Details are on page 66.
- The Black Level and Virtual Surround settings will be saved even if the player is turned off.

DVD

74 Language Settings

You can use the LANGUAGE settings to select different languages for the Audio or Subtitles of DVDs, as well as languages for DVD Disc menus.

- Before you begin, press **SELECT** to put the TV/VCR/DVD in DVD mode. The green DVD light will appear on the front of the TV/VCR/DVD.

1 Press **SET-UP** once so the **MAIN MENU** appears.

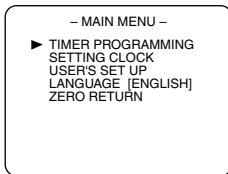

2 While playback is stopped, press **SET-UP** again. The **QUICK SETUP** screen appears.

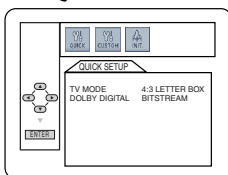

3 Press **◀** or **▶** to select **CUSTOM** at the top of the menu, then press **ENTER**.

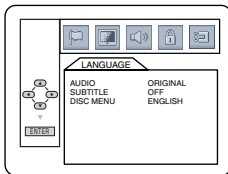

4 (LANGUAGE) will be selected. Press **ENTER**.

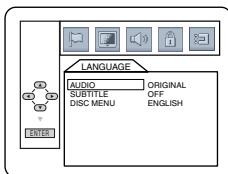

5 Press **▲** or **▼** to select **AUDIO**, **SUBTITLE** or **DISC MENU**. Then, press **ENTER**. The language options for the selected item will appear.

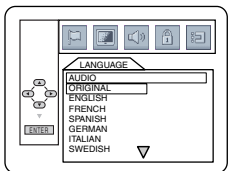

AUDIO:
The DVD's audio plays in the selected language.

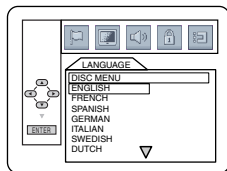

DISC MENU:
A DVD's Disc menu appears in the selected language.

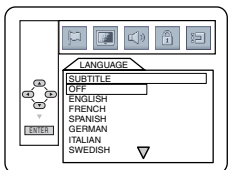

SUBTITLE:
Subtitles appear in the selected language.

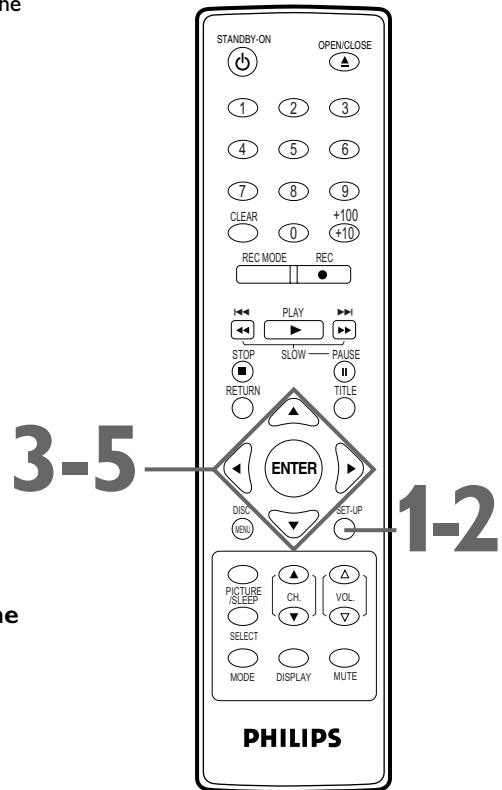

Helpful Hints

- If the DVD's default settings for Audio and Subtitle are the same language, the subtitles may not show unless you turn them on.
- Use **MODE** to select Audio and Subtitles available on the DVD. Details are on pages 65-66.
- If you set **AUDIO** to **ORIGINAL**, the default setting of the DVD Audio will play.

Language Settings (cont'd) 75

6 Press **▲** or **▼** to select a language, then press **ENTER**. The language lists may continue on multiple screens. Press **▲** or **▼** to move to the other screens.

- If you select **OTHER**, press four Number buttons to enter the code for the language you desire. Use the Language Codes below. The language or language code you select will appear in the Language menu beside **AUDIO**, **SUBTITLE** or **DISC MENU**.

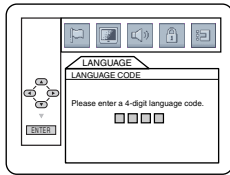

- You can select other languages for **AUDIO**, **SUBTITLE** and **DISC MENU** only if the language is available on the disc. If the language is not recorded on the DVD, changing these settings will have no effect.

7 Press **SET-UP** to exit the menu.

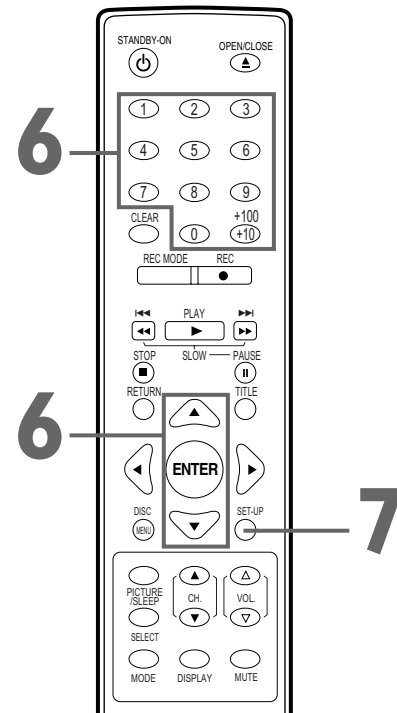

Language Codes

A-B	English	5160	Kannada	5760	Panjabi	6247	T		
Abkhazian	4748	Esperanto	5161	Kashmiri	5765	Pashto	6265	Tagalog	6658
Afar	4747	Estonian	5166	Kazakh	5757	Persian	5247	Tajik	6653
Afrikaans	4752	F-H		Kinyarwanda	6469	Polish	6258	Tamil	6647
Albanian	6563	Faroese	5261	Kirghiz	5771	Portuguese	6266	Tatar	6666
Amharic	4759	Fiji	5256	Kirundi	6460	Pushto	6265	Telugu	6651
Arabic	4764	Finnish	5255	Korean	5761	Quechua	6367	Thai	6654
Armenian	5471	French	5264	Kurdish	5767	Rhaeto-Romance	6459	Tibetan	4861
Assamese	4765	Frisian	5271	L-N		Romanian	6461	Tigrinya	6655
Aymara	4771	Gaelic (Scots)	5350	Laothian	5861	Russian	6467	Tonga	6661
Azerbaijani	4772	Galician	5358	Latin	5847			Tsonga	6665
Bangla	4860	Georgian	5747	Latvian	5868	S		Turkish	6664
Bashkir	4847	German	5051	Lettish	5868	Samoan	6559	Turkmen	6657
Basque	5167	Greek	5158	Lingala	5860	Sangho	6553	Twí	6669
Bengali	4860	Greenlandic	5758	Lithuanian	5866	Sanskrit	6547	U-Z	
Bhutani	5072	Guarani	5360	Macedonian	5957	Serbian	6564	Ukrainian	6757
Bihari	4854	Gujarati	5367	Malagasy	5953	Serbo-Croatian	6554	Urdu	6764
Bislama	4855	Hausa	5447	Malay	5965	Sesotho	6566	Uzbek	6772
Breton	4864	Hebrew	5569	Malayalam	5958	Setswana	6660	Vietnamese	6855
Bulgarian	4853	Hindi	5455	Maltese	5966	Shona	6560	Volapuk	6861
Burmese	5971	Hungarian	5467	Maori	5955	Sindhi	6550	Welsh	4971
Byelorussian	4851	I-K		Marathi	5964	Singhalese	6555	Wolof	6961
C-E		Icelandic	5565	Moldavian	5961	Siswat	6565	Xhosa	7054
Cambodian	5759	Indonesian	5560	Mongolian	5960	Slovak	6557	Yiddish	5655
Catalan	4947	Interlingua	5547	Nauru	6047	Slovenian	6558	Yoruba	7161
Chinese	7254	Interlingue	5551	Nepali	6051	Somali	6561	Zulu	7267
Corsican	4961	Inupiak	5557	Norwegian	6061	Spanish	5165		
Croatian	5464	Irish	5347	O-R		Sundanese	6567		
Czech	4965	Italian	5566	Occitan	6149	Swahili	6569		
Danish	5047	Japanese	5647	Oriya	6164	Swedish	6568		
Dutch	6058	Javanese	5669	Oromo (Afan)	6159				

DVD

76 Display Settings

You can change the TV Aspect ratio and still mode clarity in the Display menu.

- **Before you begin, press SELECT** to put the TV/VCR/DVD in DVD mode. The green DVD light will appear on the front of the TV/VCR/DVD.

1 Press SET-UP once so the MAIN MENU appears.

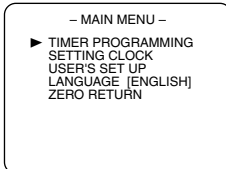

2 While playback is stopped, press SET-UP again. The QUICK SETUP screen will appear.

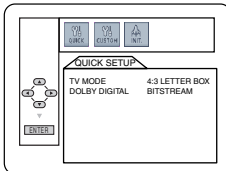

3 Press ◀ or ▶ to select CUSTOM at the top of the menu, then press ENTER.

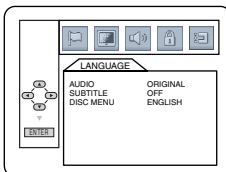

4 Press ◀ or ▶ to select [DISPLAY] (DISPLAY), then press ENTER.

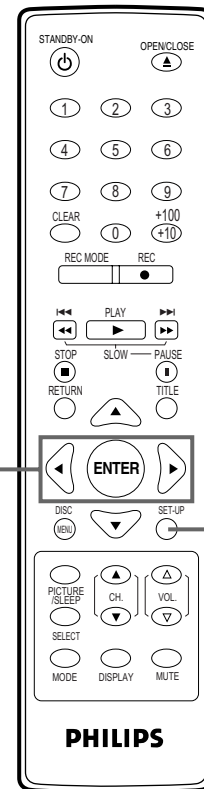
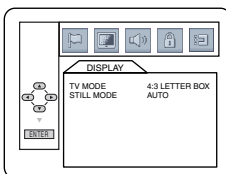

Helpful Hints

- Selecting a different TV MODE setting is only effective if it is available on the DVD. Check the DVD Disc menu or case for details.
- You also can adjust TV MODE in the QUICK SETUP menu. With QUICK selected, press ENTER. TV MODE will be selected, so press ENTER. Press ▲ or ▼ to choose a setting, then press ENTER. Press SET-UP to remove the menu.

Display Settings (cont'd) 77

5 Press ▲ or ▼ to select an item, then press ENTER.

- If you selected **TV MODE**, press ▲ or ▼ to select a setting, then press **ENTER**.

Choose 4:3 LETTER BOX if you want to see the entire, widened picture with black bars at the top and bottom of the screen. This looks like the picture you see when watching movies in a theater. This setting is possible only if the DVD was recorded in the letterbox or widescreen format. Choose 4:3 PAN & SCAN for a full height picture, with both sides trimmed. Some companies refer to this as reformatting the picture to fit your TV screen and may call it the regular or normal format.

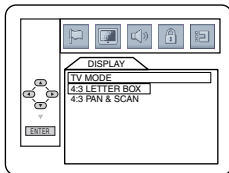

TV MODE

- If you selected **STILL MODE**, press ▲ or ▼ to select a setting, then press **ENTER**.

This function allows you to adjust the quality of a still image. AUTO is the default setting. If you select FIELD, still images will be stabilized but coarse due to the limited amount of data. If you select FRAME, the picture quality will be improved due to the simultaneous output of two field data but the image can be unstabilized.

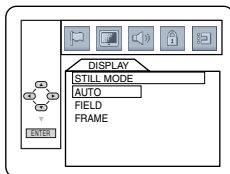

STILL MODE

6 Press **SET-UP** to exit the menu.

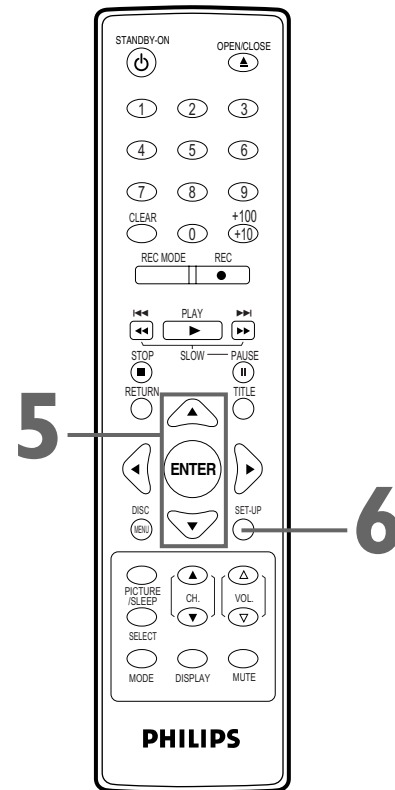

DVD

78 Audio Settings

Change Audio settings based on other equipment you connected to the TV/VCR/DVD or according to your disc sound features. These settings only affect the Audio from the DVD player of the TV/VCR/DVD.

- **Before you begin, press SELECT** to put the TV/VCR/DVD in DVD mode. The green DVD light will appear on the front of the TV/VCR/DVD.

- 1 Press **SET-UP** once so the **MAIN MENU** appears.

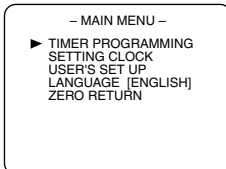

- 2 While playback is stopped, press **SET-UP** again. The **QUICK SETUP** screen will appear.

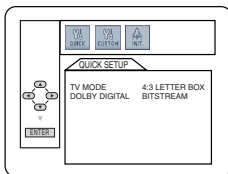

- 3 Press **◀** or **▶** to select **CUSTOM** at the top of the menu, then press **ENTER**.

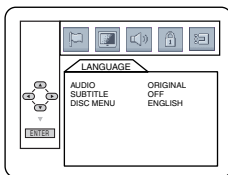

- 4 Press **◀** or **▶** to select **AUDIO**, then press **ENTER**.

- 5 Press **▲** or **▼** to select **DRC**, **DOWN SAMPLING**, or **DOLBY DIGITAL**, then follow step 6 accordingly.

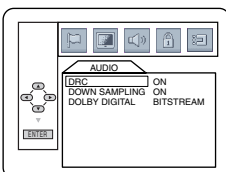

DRC

- 6
 - If you selected **DRC**, press **ENTER** repeatedly to turn Dynamic Range Control (DRC) ON or OFF. Choosing ON compresses the range of volume by suppressing loud sounds and raising low sounds. DRC is available only on discs recorded in the Dolby Digital format.
 - If you selected **DOWN SAMPLING**, press **ENTER** repeatedly to choose ON or OFF. ON sets downsampling to 48 kHz. OFF sets downsampling to 96 kHz. DOWN SAMPLING is available only when the unit is connected to a Stereo using the AUDIO OUT COAXIAL jack.
 - If you selected **DOLBY DIGITAL**, press **ENTER** repeatedly to select BITSTREAM or PCM. Select BITSTREAM if you used the AUDIO OUT COAXIAL jack to connect the TV/VCR/DVD to a stereo that is Dolby Digital compatible. Details are on page 11. Otherwise, choose PCM.

- 7 Press **SET-UP** to exit the menu.

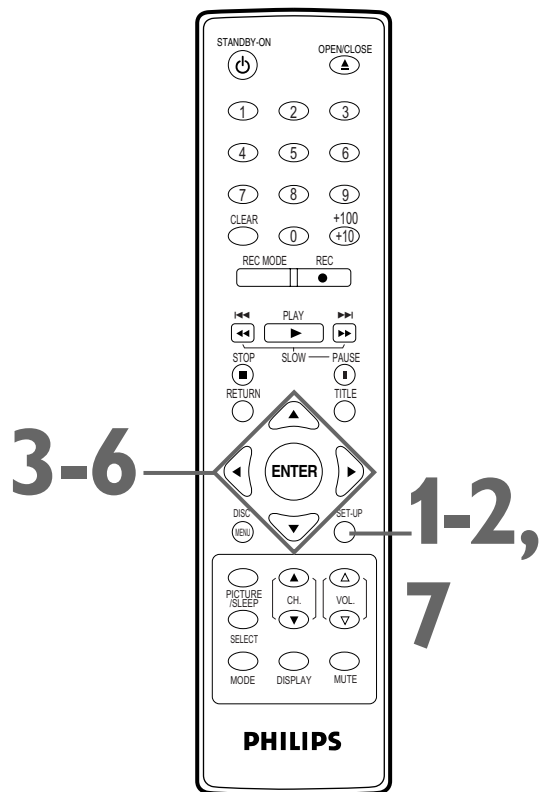

Helpful Hints

- Dolby Digital sound must be available on the DVD.
- You can adjust **DOLBY DIGITAL** in the **QUICK SETUP** menu. With **QUICK** selected, press **ENTER**. Press **▼** to select **DOLBY DIGITAL**. Press **ENTER** to choose **BITSTREAM** or **PCM**. Press **SET-UP** to remove the menu.
- When you play a disc that has copyright protection, downsampling will be at 48 kHz, even if **DOWN SAMPLING** is OFF.

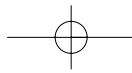

DVD

Parental Settings 79

The Parental feature prevents viewing of DVDs that exceed your rating limits. This feature will not limit viewing if the DVD is not rated or coded. Check your DVDs and settings before letting children access the TV/VCR/DVD. Follow these steps to set the Parental Level.

- **Before you begin, press SELECT** to put the TV/VCR/DVD in DVD mode. The green DVD light will appear on the front of the TV/VCR/DVD.

1 Press **SET-UP** once so the **MAIN MENU** appears.

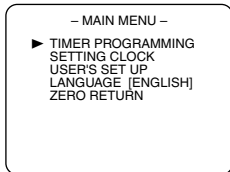

2 While playback is stopped, press **SET-UP** again.

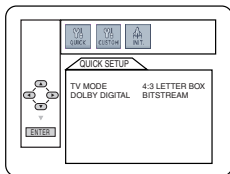

3 Press **◀** or **▶** to select **CUSTOM** at the top of the menu, then press **ENTER**.

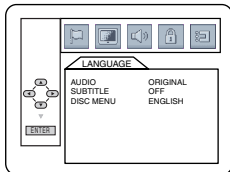

4 Press **◀** or **▶** to select **(PARENTAL)**, then press **ENTER**.

- If this is the first time to access the Parental menu, proceed to step A.
- If this is not the first time to access the Parental menu and you had already set the password before, proceed to step B.

A The display shown below will appear.

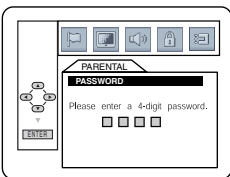

Press the **Number** buttons to enter a **4-digit password**. The password will appear on the screen. Write it down so you don't forget it.

Press **ENTER**. The Parental menu will appear.

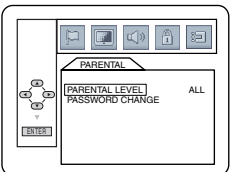

Proceed to step 5.

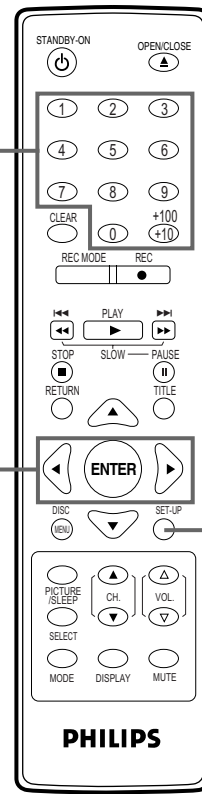

Instructions continue on the next page.

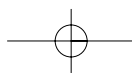

DVD

80 Parental Settings (cont'd)

Instructions continued from the previous page.

B The display shown below will appear.

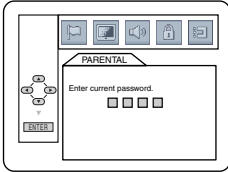

Press the Number buttons to enter your current 4-digit password. Asterisks (*) will appear instead of your password. This protects its identity. After entering the password, the Parental menu will appear.

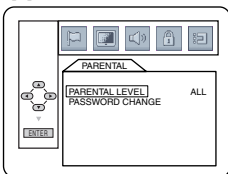

Proceed to step 5.

5 Press ▲ or ▼ to select PARENTAL LEVEL, then press ENTER.

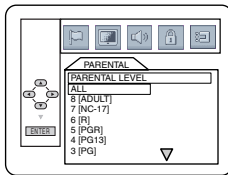

6 Press ▲ or ▼ to select a level, then press ENTER.

The previous menu will appear. The level you selected will appear beside PARENTAL LEVEL. The rating levels continue on two menu screens. Press ▲ or ▼ repeatedly to move to the next or previous screen to find the rating level you want.

7 Press SET-UP to exit the menu.

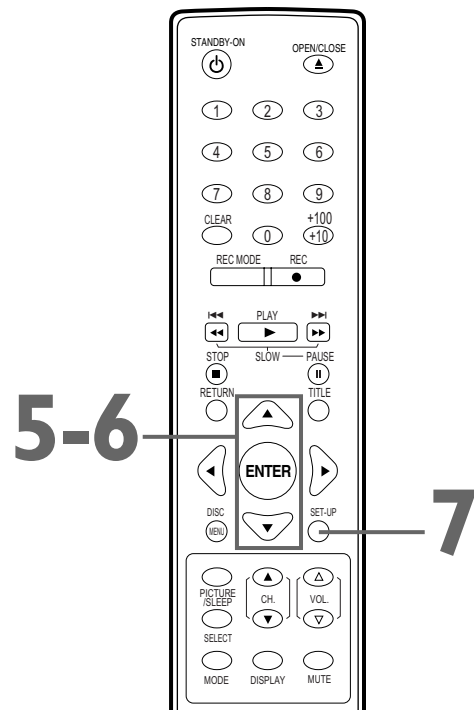

RATING EXPLANATIONS

- ALL - The Parental feature is inactive; all discs can play.
- 8 [ADULT] - DVD softwares of any grades (adult/general/children) can be played back.
- 7 [NC-17] - No one under 17 admitted
- 6 [R] - Restricted; under 17 requires accompanying parent or adult guardian
- 5 [PGR] - Parental Guidance Recommended
- 4 [PG13] - Unsuitable for children under 13
- 3 [PG] - Parental Guidance suggested
- 2 [G] - General Audience
- 1 [KID SAFE] - Suitable for children

Helpful Hints

- When you try to play a DVD whose rating exceeds the level you set, an on-screen message will indicate the DVD cannot play. Remove the DVD, then set PARENTAL LEVEL to ALL. Reload the DVD and begin playback. Some DVDs may let you enter your 4-digit password to begin playback. Follow the on-screen messages as prompted.
- You cannot use the default password (4737) to play a DVD.

Parental Settings (cont'd) 81

Changing the Parental Password

- 1** If you like to change the password, repeat 1-4B on pages 79-80.
- 2** Press **▲** or **▼** to select **PASSWORD CHANGE**, then press **ENTER**.

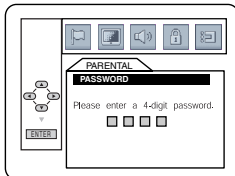

- 3** Press the **Number** buttons to enter a **4-digit password**. The password numbers will appear on the screen. Write down the password so you will not forget it. Press **ENTER**. The previous menu will reappear.

- 4** Press **SET-UP** to exit the menu.

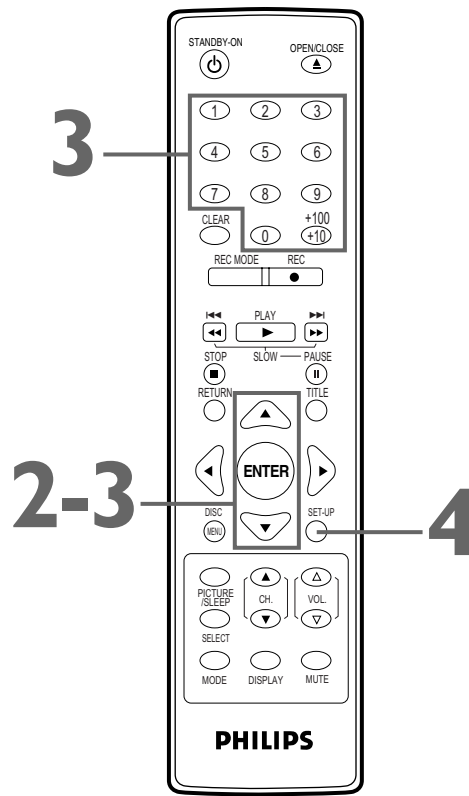

Helpful Hints

- The default password is 4737. If you forget your password, press Number buttons 4, 7, 3, 7 at step 4B on page 80. You will be prompted to enter a new 4-digit password. Use the Number buttons to enter a new 4-digit password, then press ENTER. PARENTAL LEVEL will reset to ALL. Press SET-UP to remove the menu. See pages 79-80 to reset PARENTAL LEVEL as you desire.
- A power failure will not erase your password.

DVD

82 Others

You may adjust the Angle Icon, Automatic Power Off, Dual Playback and Slide Show settings.

- **Before you begin, press SELECT** to put the TV/VCR/DVD in DVD mode. The green DVD light will appear on the front of the TV/VCR/DVD.

1 Press SET-UP once so the MAIN MENU appears.

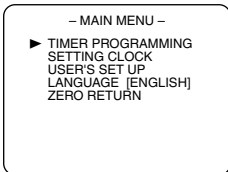

2 While playback is stopped, press SET-UP again. The QUICK SETUP screen will appear.

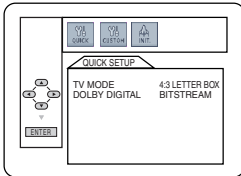

3 Press ◀ or ▶ to select CUSTOM at the top of the menu, then press ENTER.

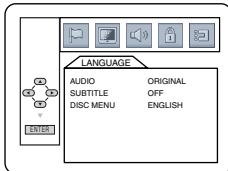

4 Press ◀ or ▶ to select OTHERS, then press ENTER.

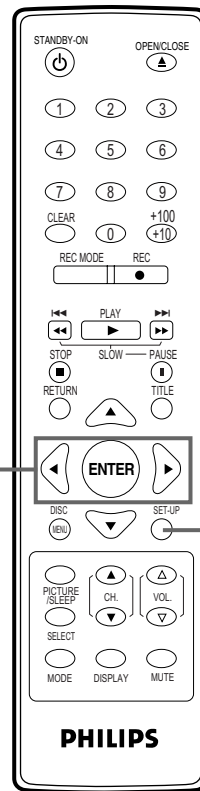
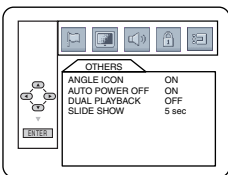

Others (cont'd) 83

5 Press ▲ or ▼ to select an item, then press ENTER.

- If you selected **ANGLE ICON**, press **ENTER** repeatedly to select **ON** or **OFF**. The default setting is **ON**. Choose **ON** to see the Angle icon when multiple camera angles are available during DVD playback. Details are on page 65. Choose **OFF** to disable the Angle icon.

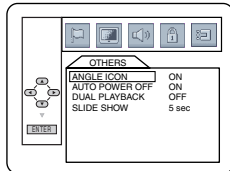

ANGLE ICON

- If you selected **AUTO POWER OFF**, press **ENTER** repeatedly to choose **ON** or **OFF**. The default setting is **ON**. Choose **ON** if you want the player to turn off when there is no activity at the player or its remote for 20 minutes.

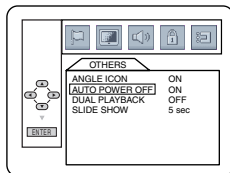

AUTO POWER OFF

- If you selected **DUAL PLAYBACK**, press **ENTER** to choose **ON** or **OFF**. This feature lets you play **MP3** and **JPEG** files simultaneously.

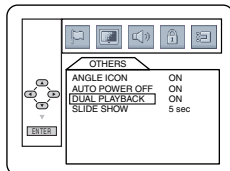

DUAL PLAYBACK

- If you selected **SLIDE SHOW**, press **▲** or **▼** to choose **5 sec** or **10 sec**, then press **ENTER**. This adjusts the playback speed of the **SLIDE SHOW**. The default setting is **5 sec**. Choose **5 sec** to display each image for 5 seconds. Choose **10 sec** to display each image for 10 seconds.

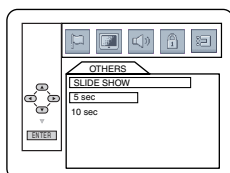

SLIDE SHOW

6 Press **SET-UP** to exit the menu.

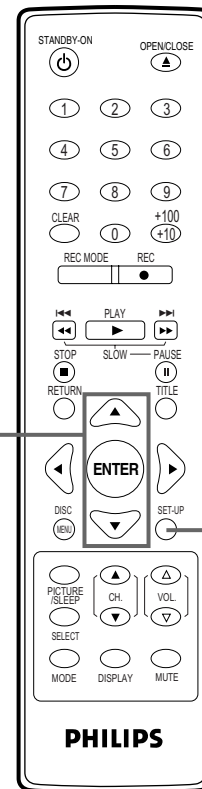

84 Glossary

AUDIO In Jacks: red and white jacks on the front of the TV/VCR/DVD which are used to receive or record audio from another source (VCR, Camcorder, etc.).

Automatic Channel Setup: process in which the TV/VCR/DVD memorizes all available TV channels. Then, when you push CH. ▲/▼, you only scan through channels you receive.

Auxiliary (AUX): The channel to which you set your TV/VCR/DVD during dubbing or when viewing material that is playing on another device that is connected to the TV/VCR/DVD (for example, a Camcorder or VCR or TV channels from a Cable Box/Satellite Receiver). Press SELECT to choose AUX at the TV/VCR/DVD.

Bands: settings that allow you to tune channels.

- **Antenna** – VHF (very high frequency; channels 2-13) and UHF (ultra high frequency; channels 14-69).
- **Cable** – standard channels can be received without a Cable Box.

Brightness: adjusting increases or decreases the brightness of the color on the screen.

Digital AUDIO OUT COAXIAL Jack: Sends digital audio to a stereo, allowing you to adjust the volume at the stereo.

Color: adjusting pales or brightens the TV/VCR/DVD picture color.

Dolby Digital: A surround sound system that provides Multi-channel sound as used in movie theaters. Sound is heard through multiple channels, not just the right and left as with standard stereo.

Dubbing: copying a videotape from a separate VCR or camcorder.

HQ: high quality; a feature in the VCR circuitry which provides enhanced videotape picture detail through the TV/VCR/DVD.

OTR: One-Touch Recording; a timed recording that starts immediately and records for 30 minutes to 8 hours, whichever you specify.

Sharpness: adjusting softens or clarifies the picture on the screen.

Tape Speeds: how fast the videotape travels during playback or recording. The faster the tape speed, the better the recording quality will be. Faster speeds (SP) also use more space on the tape. So, you can put more recording on a tape if you use a slower tape speed (SLP).

- **SP** (Standard Playback) – fastest tape speed (recording time for a T120 tape is approximately 2 hours); best picture quality.
- **LP** (Long Playback) – average tape speed; only playback in this speed is available on this TV/VCR/DVD.
- **SLP** (Super Long Playback) – slowest tape speed (recording time for a T120 tape is approximately 6 hours).

Tint: adjusting changes the tints of the picture from purple to green.

VIDEO In Jack: yellow jack on the front of the TV/VCR/DVD which is used to receive or record video from another source (VCR, Camcorder, etc.).

Helpful Hints 85

If you are having problems with your product, check this list of problems and possible solutions before requesting service. You may be able to solve the problem yourself.

Location

For safe operation and satisfactory performance of your TV/VCR/DVD, remember the following:

- Shield it from direct sunlight and keep it away from sources of intense heat.
- Avoid dusty or humid places.
- Avoid places with insufficient ventilation. Do not block the ventilation openings at the top and bottom of the TV/VCR/DVD. Do not place the TV/VCR/DVD on a carpet, as this will block the ventilation openings.
- Avoid locations subject to strong vibrations.
- Do not place the TV/VCR/DVD near strong magnetic fields.
- Do not move the TV/VCR/DVD from a cold place to a hot place, or vice versa.

Electrical Shock and Fire Hazards

- Do not handle the power cord with wet hands.
- Do not pull the power cord when disconnecting the TV/VCR/DVD from the AC (alternating current) wall outlet. Grasp it by the plug.
- If you spill water on the TV/VCR/DVD, unplug the power cord immediately and take the TV/VCR/DVD to an authorized service center.
- Do not put your fingers or objects into the cassette compartment or disc tray.
- Do not place anything on top of the TV/VCR/DVD.

Dew Warning (Moisture Condensation)

- Moisture may condense inside the unit when you move it from a cold place to a warm place, after heating a cold room, or when the humidity is high. There is no warning that moisture is in your TV/VCR/DVD. Playing a tape when moisture has accumulated could damage the tape and the TV/VCR/DVD. If you suspect moisture inside the TV/VCR/DVD, keep the power on (but do not play a tape) for at least 2 hours. This will allow the TV/VCR/DVD to dry.

TV/VCR/DVD will not perform a timer recording.

- Set the recording start and stop times correctly. *Details are on pages 31-34.* Midnight is 12 a.m. Noon is 12 p.m.
- Make sure the TV/VCR/DVD power is off for the timer recording.
- Set the clock. *Details are on pages 21-24.*
- Put a videotape in the cassette compartment of the TV/VCR/DVD. The tape must have a record tab. *Details are on page 8.*
- If the power fails, timer recordings will be restored when you reset the clock. Timer recordings do not occur if set to take place during the power failure.

TV/VCR/DVD will not record on a videotape.

- Make sure the videotape has a record tab. *Details are on page 8.*
- Plug the power cord into an active AC outlet. *Details are on page 10.*
- Check your hookups. *Details are on pages 9-10.*
- Set up the TV channels. *Details are on page 19.*
- You cannot record DVDs onto a videotape using the TV/VCR/DVD.

Channel reception is poor.

- Check connections, then set up the channels again. *Details are on page 19.*

TV/VCR/DVD has no power.

- Connect the power plug to an AC (alternating current) outlet completely.

TV/VCR/DVD ejects the tape when you try to start a recording.

- Make sure the tape has a record tab. *Details are on page 8.*

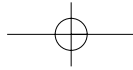

86 Helpful Hints (cont'd)

Disc cannot play.

- Insert a playable disc. Make sure the disc is labelled for Region 1 or ALL regions and is NTSC compatible. *Details are on page 7.*
- Place the disc correctly in the disc tray. If the disc is one-sided, place the disc in the tray with the label facing up. If the disc is two-sided, make sure the label of the side you want to play is facing up.
- Clean the disc. Make sure the disc is not scratched or warped.
- Cancel the Parental Controls, enter the password, or change the Parental level. *Details are on pages 79-80.*

TV/VCR/DVD does not have a picture.

- Adjust the antenna or check the Cable TV or satellite signal connection. If using a Cable Box/Satellite Receiver, set the TV/VCR/DVD to channel 3, 4 or AUX. *Details are on pages 9-10.*
- Adjust the picture controls. *Details are on page 28.*
- Select an active TV channel. *Details are on pages 19-20.*
- Make sure the disc is compatible with the DVD player of the TV/VCR/DVD. *Details are on page 7.*

TV/VCR/DVD has poor sound or no sound.

- Press VOL. Δ/∇ to adjust the volume. Press MUTE to restore the volume.
- Check the audio settings for DVD mode. *Details are on page 78.*
- Check the audio settings of the disc. For example, you may have selected "soundtrack" playback or an unavailable sound setting (such as Dolby Digital) or language. *Details are on pages 66, 74-75 and 78.* Try other sound options provided in the DVD Disc menu.

You cannot choose a DVD feature, such as camera angle or audio or subtitle language.

- The feature must be recorded on the DVD. Not all DVDs contain multiple angles, subtitles, etc. Refer to the disc case to see what features are available. If the feature is not available, the "X" may appear in the top right corner of the screen.

Videotape playback is poor or the tape is destroyed.

- Adjust the tracking. *Details are on page 43.*
- Use the Rental feature. *Details are on page 38.*
- If moisture has accumulated in the unit, keep the power on for at least 2 hours, but do not play a tape.

TV/VCR/DVD does not display closed captions for TV programs.

- Make sure closed captioning is available for the program. Refer to the TV listings in your local newspaper.

Remote control does not operate the TV/VCR/DVD.

- Aim the remote control directly at the remote sensor on the front of the TV/VCR/DVD. *Details are on page 14.*
- Remove all obstacles between the remote control and the TV/VCR/DVD.
- Inspect and replace the batteries in the remote control. *Details are on page 8.*

Number buttons will not select channels above 69.

- Enter channel numbers as a 2-digit number. If you want to select channels 100 and above, press the +100/+10 button, then the Number buttons for the last 2 digits. *Details are on page 13.*
- If you are using an antenna and do not have Cable TV/Satellite, only channels 2-69 will be available.

You cannot insert a tape into the cassette compartment of the TV/VCR/DVD.

- Insert the tape with the window facing up and the record tab facing you and on the left.
- Make sure a tape isn't already inside by pressing STOP/EJECT $\blacksquare \blacktriangle$ on the front of the TV/VCR/DVD.
- Gently push on the center of the tape. Never force a tape into the TV/VCR/DVD.
- If you have set a timer recording and the power is off, the unit will eject the tape if the record tab is missing.

You cannot remove the tape from the TV/VCR/DVD.

- Make sure the power plug is completely connected to an AC (alternating current) outlet.
- If a timer recording is programmed, turn on the TV/VCR/DVD power, then eject the tape. Be sure to insert a tape and turn off the TV/VCR/DVD power for the timer recording.
- Unplug the TV/VCR/DVD power cord for 5 minutes. Then, plug in the power cord again, then press STANDBY-ON \odot on the TV/VCR/DVD. If the tape does not eject, press STOP/EJECT $\blacksquare \blacktriangle$ on the TV/VCR/DVD three to five times. If the tape still does not eject, an authorized servicer may need to remove the tape.

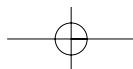

Specifications 87

General TV/VCR

CRT: 29 inch in-line gun
90° deflection tube

Closed Caption system: 15.119/FCC

Video Heads: Rotary four-head

Tape width: 1/2 inch

Tape speeds

SP 33.40 mm/sec.

SLP 11.12 mm/sec.

Tuner channels: 2-69

Cable TV: 1-125

DTV 2-69

General DVD

Color System: NTSC

Electrical Specifications

Sound output: Two speakers, 1W, 8 ohm

Other Specifications

Terminals

Antenna In: VHF/UHF/Cable TV/DTV
75 ohm unbalanced (F-type)

Video In: One RCA connector

Audio L/R In: Two RCA connectors

Headphone: 1/8" stereo (3.5 mm)

Coaxial Digital

Audio Out: One pin jack,
500m Vpp (75 ohm)

Operating

temperature: 41°F-104°F (5°C-40°C)

Power requirements: AC 120V, 60Hz

Power consumption

(Maximum): 145W

Dimensions: Height: 25.4" (644 mm)

Width: 26.7" (677.3 mm)

Depth: 20.3" (515.1 mm)

Weight: 86.2 lbs. (39.2 kg)

Designs and specifications are subject to change without notice and without our legal obligation.

88 Limited Warranty

PHILIPS LIMITED WARRANTY NINETY (90) DAY LABOR / ONE (1) PARTS / TWO (2) YEAR DISPLAY

WARRANTY COVERAGE:

PHILIPS warranty obligation is limited to the terms set forth below.

WHO IS COVERED:

Philips warrants the product to the original purchaser or the person receiving the product as a gift against defects in materials and workmanship as based on the date of original purchase ("Warranty Period") from an Authorized Dealer. The original sales receipt showing the product name and the purchase date from an authorized retailer is considered such proof.

WHAT IS COVERED:

The Philips warranty covers new products if a defect arises and a valid claim is received by Philips within the Warranty Period. At its option, Philips will either (1) repair the product at no charge, using new or refurbished replacement parts, or (2) exchange the product with a product that is new or which has been manufactured from new, or serviceable used parts and is at least functionally equivalent or most comparable to the original product in Philips current inventory, or (3) refund the original purchase price of the product.

Philips warrants replacement products or parts provided under this warranty against defects in materials and workmanship from the date of the replacement or repair for ninety (90) days or for the remaining portion of the original product's warranty, whichever provides longer coverage for you. When a product or part is exchanged, any replacement item becomes your property and the replaced item becomes Philips' property. When a refund is given, your product becomes Philips' property.

Note: Any product sold and identified as refurbished or renewed carries a ninety (90) day limited warranty.

Replacement product can only be sent if all warranty requirements are met. Failure to follow all requirements can result in delay.

WHAT IS NOT COVERED - EXCLUSIONS AND LIMITATIONS:

This Limited Warranty applies only to the new products manufactured by or for Philips that can be identified by the trademark, trade name, or logo affixed to it. This Limited Warranty does not apply to any non-Philips hardware product or any software, even if packaged or sold with the product. Non-Philips manufacturers, suppliers, or publishers may provide a separate warranty for their own products packaged with the bundled product.

Philips is not liable for any damage to or loss of any programs, data, or other information stored on any media contained within the product, or any non-Philips product or part not covered by this warranty. Recovery or reinstallation of programs, data or other information is not covered under this Limited Warranty.

This warranty does not apply (a) to damage caused by accident, abuse, misuse, misapplication, or non-Philips product, (b) to damage caused by service performed by anyone other than Philips or Philips Authorized Service Location, (c) to a product or a part that has been modified without the written permission of Philips, or (d) if any Philips serial number has been removed or defaced, or (e) product, accessories or consumables sold "AS IS" without warranty of any kind by including refurbished Philips product sold "AS IS" by some retailers.

This Limited Warranty does not cover:

- Shipping charges to return defective product to Philips.
- Labor charges for installation or setup of the product, adjustment of customer controls on the product, and installation or repair of antenna systems outside of the product.
- Product repair and/or part replacement because of improper installation, connections to improper voltage supply, abuse, neglect, misuse, accident, unauthorized repair or other cause not within the control of Philips.
- Damage or claims for products not being available for use, or for lost data or lost software.
- Damage occurring to product during shipping.
- A product that requires modification or adaptation to enable it to operate in any country other than the country for which it was designed, manufactured, approved and/or authorized, or repair of products damaged by these modifications.
- A product used for commercial or institutional purposes (including but not limited to rental purposes).
- Product lost in shipment and no signature verification receipt can be provided.
- Failure to operate per Owner's Manual.

TO OBTAIN ASSISTANCE IN THE U.S.A., PUERTO RICO, OR U.S. VIRGIN ISLANDS...

Contact Philips Customer Care Center at:
1-888-PHILIPS (1-888-744-5477)

TO OBTAIN ASSISTANCE IN CANADA...

1-800-661-6162 (French Speaking)
1-888-PHILIPS (1-888-744-5477) - (English or Spanish Speaking)

REPAIR OR REPLACEMENT AS PROVIDED UNDER THIS WARRANTY IS THE EXCLUSIVE REMEDY FOR THE CONSUMER. PHILIPS SHALL NOT BE LIABLE FOR ANY INCIDENTAL OR CONSEQUENTIAL DAMAGES FOR BREACH OF ANY EXPRESS OR IMPLIED WARRANTY ON THIS PRODUCT. EXCEPT TO THE EXTENT PROHIBITED BY APPLICABLE LAW, ANY IMPLIED WARRANTY OF MERCHANTABILITY OR FITNESS FOR A PARTICULAR PURPOSE ON THIS PRODUCT IS LIMITED IN DURATION TO THE DURATION OF THIS WARRANTY.

Some states do not allow the exclusions or limitation of incidental or consequential damages, or allow limitations on how long an implied warranty lasts, so the above limitations or exclusions may not apply to you.

This warranty gives you specific legal rights. You may have other rights which vary from state/province to state/province.

Philips, P.O. Box 671539, Marietta, GA. 30006-0026

3121 233 4881 I

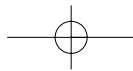

Index 89

- a-b repeat63
 ant(enna) jack9-10, 15
 arrow buttons12
 audio cd7
 audio in/out jacks10, 14, 36
 audio out coaxial jack11, 15
 audio settings (dvd)78
 auto return35
 automatic rewind, eject43
 auxiliary mode (aux) ..9-10, 16, 36, 84

 batteries8
 black level73
 brightness28

 camera angle65
 cassette compartment14
 channel
 above 10013, 61
 adding/deleting20
 setup19
 ▲/▼ buttons12, 14, 16, 43
 chapters60
 clear button13, 34, 39
 clock setting21-24
 closed captions44-47
 color28
 connections9-11, 36
 contents, table of5
 contrast28
 controls
 remote12-13
 tv/vcr/dvd14
 copyright protection4, 36
 counter27, 39

 daylight-savings time25
 disc menu button12, 58
 disc tray14, 18
 display button13, 27, 71-72
 display settings76-77
 duplication36
 dvd light14
 dvd video7

 ejecting a tape14, 86
 enter button13

 fast forward search42, 59
 front panel14

 glossary84

 headphone jack14
 helpful hints85-86
 hookups9-11, 36

 language (dvd)66, 74-75
 language (setup menus)19
 language settings74-75
 lp (long playback)29, 84

 menus6, 19, 58
 mode button13, 68, 73
 mp3 display72
 mp3 playback69
 mp3 track selection69
 mts system55-57
 mute button13

 number buttons13

 on-screen status displays ..27, 71-72
 one-touch recording30
 open/close ▲ button12, 14

 parental controls79-81
 password81
 pause ■■ button12, 42, 62, 67
 picture controls28
 play ► button12, 14, 17-18
 playing discs18
 playing videotapes17
 power cord10, 15
 programs68

 random playback68
 ratings
 mpaa52
 tv48-51
 real-time tape counter39
 rear panel15
 rec mode button12, 29
 rec ● button12, 29
 recording
 basic29
 one-touch30
 timer31-34
 rec/otr ● button14
 rec/otr light14
 remote control
 buttons12-13
 using8
 remote sensor14
 repeat playback37, 63
 rerecording36
 resuming playback62
 return button13
 reverse searching42, 59
 rf coaxial cable9

 safety precautions4
 searching42, 59

 second audio program55-57
 select button12
 setup button6, 13
 sharpness28
 sleep timer39
 slow motion42, 67
 slp (super long playback) ...29, 84
 source button14
 sp (standard playback)29, 84
 specifications87
 standby-on ☺ button12, 14
 status display27, 71-72
 stereo broadcast recording ..55-57
 still picture42, 62
 stop ■ button12
 stop/eject ■/▲ button14, 17
 super high speed searching ...42

 table of contents5
 tape duplication36
 tape eject14, 86
 tape speed29, 84
 time search40
 time setting21-24
 timer recording
 cancelling34
 checking34
 setting31-33
 tint28
 title button13, 58
 titles58
 tracking43
 tracks61

 vcr/tv light14
 v-chip setup48-53
 video in/out jacks10, 14, 36
 virtual surround73
 volume ▲/▼ buttons12, 14

 warranty88
 Windows Media™ Audio display ...72
 Windows Media™ Audio playback ...69

 zero return39

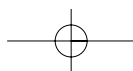

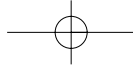

90 MEMO

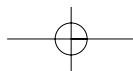
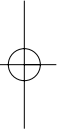

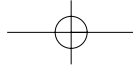

MEMO 91

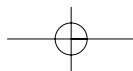
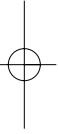

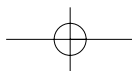

PHILIPS CONSUMER ELECTRONICS

A Division of Philips Electronics North America Corp
P.O. Box 671539 Marietta, GA 30006 0026

Meet Philips at the Internet
<http://www.philips.com/usasupport>

 Be responsible
Respect copyrights

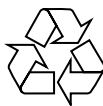

27PC4326/37



8239 300 47411

