

Owner's Manual

Please read before using this unit.

DVD/CD Player with Video Cassette Recorder PY840G



INSTRUCCIONES EN
ESPAÑOL INCLUIDAS.

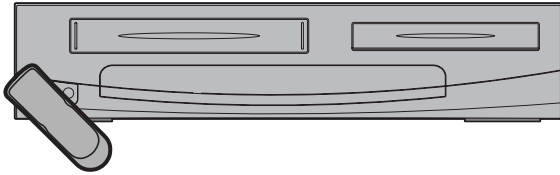

If you need additional operating assistance after reading this owner's manual, please call
TOLL FREE : 1-800-789-4230
or visit our web site at
<http://www.funai-corp.com>

Supplied Accessories



Remote control (NB183UD) with two AA batteries 	RF cable (WPZ0901TM002) 
Audio/Video cables (WPZ0102TM015 / WPZ0102LTE01) 	Owner's Manual (1VMN23006) 

Table of Contents

Precautions

Laser Safety	2
■ Important Safeguards	3
Location and Handling	4
Avoid the Hazards of Electrical Shock and Fire	4
Moisture Condensation Warning	4
About Copyright	4
Notice for Progressive Scan Outputs	4
Symbols Used in This Manual	4
Maintenance	4
■ About the Video Cassettes and Discs	5
Playable Video Cassettes	5
Playable Discs	5
Unplayable Discs	5

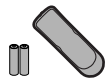
Setup

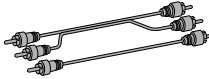
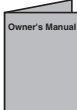
■ Connections	6
RF Output Channel	6
Hint for Cable Box or Satellite Box	6
Connection to an Audio System	6
Connection to a TV	7
■ Preparation for Use	8
Turn on the Unit for the First Time	8
To Add or Delete Channels	8
Clock Setup	8
■ Function Overview	9
Front Panel Indicator	9
VCR / DVD Switching	9
Front & Rear Terminals	9
Remote Control	10
Installing the Batteries for the Remote Control	10

VCR Functions

■ Playback	11
■ Other Operations	11
Index Search	11
Time Search	11
Auto Repeat	12

■ Recording	12
Recording & OTR (One Touch Recording)	12
Timer Recording	12
Hints for OTR and Timer Recording	13
Copying a Video Tape	14

DVD Functions

■ Playback	15
■ MP3 Playback	16
■ On-Screen Display	16
■ Search Functions	17
Using Track Search	17
Using Title / Chapter Search	17
Using Time Search	17
Marker Setup	17
■ Repeat / Random / Programmed Playback	18
Repeat Playback / Repeat A-B Playback	18
Random Playback / Programmed Playback	18
■ Special Settings	19
Subtitle Language / Audio Language / Camera Angle	19
Black Level Setting / Stereo Sound Mode / Virtual Surround	19
■ DVD Setup	20
LANGUAGE Setting	20
DISPLAY Setting	21
AUDIO Setting	21
PARENTAL Setting	22
OTHERS Setting	22
Reset to the Default Setting (Except for PARENTAL Setting) ..	23

Information

■ Troubleshooting Guide	23
■ Specifications	24
■ Language Code List	24
■ Limited Warranty	24
■ Español	25
■ Quick Use Guide	27

Basic TV Connection

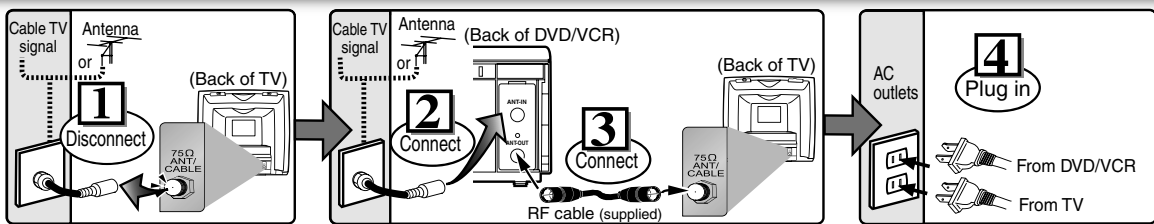

5 Please refer to "Connections" on page 6.

Precautions

WARNING: TO REDUCE THE RISK OF FIRE OR ELECTRIC SHOCK, DO NOT EXPOSE THIS APPLIANCE TO RAIN OR MOISTURE.



CAUTION
RISK OF ELECTRIC SHOCK
DO NOT OPEN



CAUTION:
TO REDUCE THE RISK OF ELECTRIC SHOCK,
DO NOT REMOVE COVER (OR BACK). NO USER
SERVICEABLE PARTS INSIDE. REFER SERVICING
TO QUALIFIED SERVICE PERSONNEL.



The lightning flash with arrowhead symbol, within an equilateral triangle, is intended to alert the user to the presence of uninsulated "dangerous voltage" within the product's enclosure that may be of sufficient magnitude to constitute a risk of electric shock to persons.



The exclamation point within an equilateral triangle is intended to alert the user to the presence of important operating and maintenance (servicing) instructions in the literature accompanying the appliance.

The caution marking is located on the rear of the cabinet.

Laser Safety

This unit employs a laser. Only a qualified service person should remove the cover or attempt to service this device, due to possible eye injury.

CAUTION: USE OF CONTROLS OR ADJUSTMENTS OR PERFORMANCE OF PROCEDURES OTHER THAN THOSE SPECIFIED HEREIN MAY RESULT IN HAZARDOUS RADIATION EXPOSURE.

CAUTION: VISIBLE AND INVISIBLE LASER RADIATION WHEN OPEN AND INTERLOCK DEFEATED. DO NOT STARE INTO BEAM.

LOCATION: INSIDE, NEAR THE DECK MECHANISM.

FCC WARNING- This equipment may generate or use radio frequency energy. Changes or modifications to this equipment may cause harmful interference unless the modifications are expressly approved in the manual. The user could lose the authority to operate this equipment if an unauthorized change or modification is made.

RADIO-TV INTERFERENCE

This equipment has been tested and found to comply with the limits for a Class B digital device, pursuant to Part 15 of the FCC Rules. These limits are designed to provide reasonable protection against harmful interference in a residential installation. This equipment generates, uses, and can radiate radio frequency energy and, if not installed and used in accordance with the instructions, may cause harmful interference to radio communications. However, there is no guarantee that interference will not occur in a particular installation. If this equipment does cause harmful interference to radio or television reception, which can be determined by turning the equipment off and on, the user is encouraged to try to correct the interference by one or more of the following measures:

- 1) Reorient or relocate the receiving antenna.
- 2) Increase the separation between the equipment and receiver.
- 3) Connect the equipment into an outlet on a circuit different from that to which the receiver is connected.
- 4) Consult the dealer or an experienced radio/TV technician for help.

This Class B digital apparatus complies with Canadian ICES-003.

Cet appareil numérique de la classe B est conforme à la norme NMB-003 du Canada.

CAUTION: TO PREVENT ELECTRIC SHOCK, MATCH WIDE BLADE OF PLUG TO WIDE SLOT, FULLY INSERT.

ATTENTION: POUR ÉVITER LES CHOC ÉLECTRIQUES, INTRODUIRE LA LAME LA PLUS LARGE DE LA FICHE DANS LA BORNE CORRESPONDANTE DE LA PRISE ET POUSSER JUSQU'AU FOND.

A NOTE ABOUT RECYCLING

This product's packaging materials are recyclable and can be reused. Please dispose of any materials in accordance with your local recycling regulations.

Batteries should never be thrown away or incinerated but disposed of in accordance with your local regulations concerning chemical wastes.

Make your contribution to the environment!!!

- Used up batteries do not belong in the dust bin.
- You can dispose of them at a collection point for used up batteries or special wastes. Contact your council for details.



For Customer Use:

Read carefully the information located at the back of this unit and enter below the Model No. and the Serial No. Retain this information for future reference.

Model No. _____

Serial No. _____

IMPORTANT SAFEGUARDS

1. Read Instructions - All the safety and operating instructions should be read before the appliance is operated.
2. Retain Instructions- The safety and operating instructions should be retained for future reference.
3. Heed Warnings - All warnings on the appliance and in the operating instructions should be adhered to.
4. Follow Instructions - All operating and use instructions should be followed.
5. Cleaning - Unplug this video product from the wall outlet before cleaning. Do not use liquid cleaners or aerosol cleaners. Use a damp cloth for cleaning.
EXCEPTION: A product that is meant for uninterrupted service and, that for some specific reason, such as the possibility of the loss of an authorization code for a CATV converter, is not intended to be unplugged by the user for cleaning or any other purpose, may exclude the reference to unplugging the appliance in the cleaning description otherwise required in item 5.
6. Attachments - Do not use attachments not recommended by the video product manufacturer as they may cause hazards.
7. Water and Moisture- Do not use this video product near water, for example, near a bath tub, wash bowl, kitchen sink, or laundry tub, in a wet basement, or near a swimming pool, and the like.
8. Accessories - Do not place this video product on an unstable cart, stand, tripod, bracket, or table. The video product may fall, causing serious injury to a child or adult, and serious damage to the appliance. Use only with a cart, stand, tripod, bracket, or table recommended by the manufacturer, or sold with the video product. Any mounting of the appliance should follow the manufacturer's instructions and should use a mounting accessory recommended by the manufacturer. An appliance and cart combination should be moved with care. Quick stops, excessive force, and uneven surfaces may cause the appliance and cart combination to overturn.
9. Ventilation - Slots and openings in the cabinet are provided for ventilation and to ensure reliable operation of the video product and to protect it from overheating, and these openings must not be blocked or covered. The openings should never be blocked by placing the video product on a bed, sofa, rug, or other similar surface. This video product should not be placed in a built-in installation such as a bookcase or rack unless proper ventilation is provided or the manufacturer's instructions have been adhered to.
10. Power Sources - This video product should be operated only from the type of power source indicated on the marking label. If you are not sure of the type of power supply to your home, consult your appliance dealer or local power company. For products intended to operate from battery power, or other sources, refer to the operating instructions.
11. Grounding or Polarization - This video product is equipped with a polarized alternating-current line plug (a plug having one blade wider than the other). This plug will fit into the power outlet only one way. This is a safety feature. If you are unable to insert the plug fully into the outlet, try reversing the plug. If the plug should still fail to fit, contact your electrician to replace your obsolete outlet. Do not defeat the safety purpose of the polarized plug.
12. Power Cord Protection - Power supply cords should be routed so that they are not likely to be walked on or pinched by items placed upon or against them, paying particular attention to cords at plugs, convenience receptacles, and the point where they exit from the appliance.
13. Outdoor Antenna Grounding - If an outside antenna or cable system is connected to the video product, be sure the antenna or cable system is grounded so as to provide some protection against voltage surges and built-up static charges. Article 810 of the National Electrical Code, ANSI/NFPA No. 70, provides information with regard to proper

grounding of the mast and supporting structure, grounding of the lead-in wire to an antenna discharge unit, size of grounding conductors, location of antenna-discharge unit, connection to grounding electrodes, and requirements for the grounding electrode. (Fig. A)

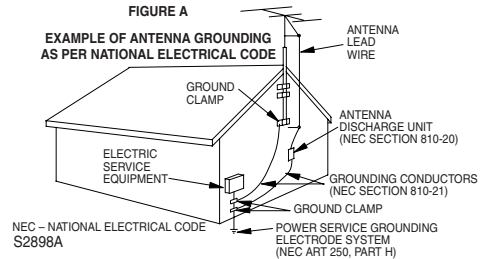

PORTABLE CART WARNING
(Symbol provided by RETAC)



14. Lightning - For added protection for this video product during a lightning storm, or when it is left unattended and unused for long periods of time, unplug it from the wall outlet and disconnect the antenna or cable system. This will prevent damage to the video product due to lightning and power-line surges.
15. Power Lines - An outside antenna system should not be located in the vicinity of overhead power lines or other electric light or power circuits, or where it can fall into such power lines or circuits. When installing an outside antenna system, extreme care should be taken to keep from touching such power lines or circuits as contact with them might be fatal.
16. Overloading - Do not overload wall outlets and extension cords as this can result in a risk of fire or electric shock.
17. Object and Liquid Entry - Never push objects of any kind into this video product through any openings as they may touch dangerous voltage points or short-out parts that could result in a fire or electric shock. Never spill liquid of any kind on the video product.
18. Servicing - Do not attempt to service this video product yourself as opening or removing covers may expose you to dangerous voltage or other hazards. Refer all servicing to qualified service personnel.
19. Damage Requiring Service - Unplug this video product from the wall outlet and refer servicing to qualified service personnel under the following conditions:
 - a. When the power-supply cord or plug is damaged.
 - b. If liquid has been spilled, or objects have fallen into the video product.
 - c. If the video product has been exposed to rain or water.
 - d. If the video product does not operate normally by following the operating instructions. Adjust only those controls that are covered by the operating instructions as an improper adjustment of other controls may result in damage and will often require extensive work by a qualified technician to restore the video product to its normal operation.
 - e. If the video product has been dropped or damaged in any way.
 - f. When the video product exhibits a distinct change in performance this indicates a need for service.
20. Replacement Parts - When replacement parts are required, be sure the service technician has used replacement parts specified by the manufacturer or have the same characteristics as the original part. Unauthorized substitutions may result in fire, electric shock or other hazards.
21. Safety Check - Upon completion of any service or repairs to this video product, ask the service technician to perform safety checks to determine that the video product is in proper operating condition.
22. Heat - This video product should be situated away from heat sources such as radiators, heat registers, stoves, or other products (including amplifiers) that produce heat.

Location and Handling

- Do not stand this unit up vertically. Install this unit in a horizontal and stable position. Do not place anything directly on top of this unit. Do not place this unit directly on top of the TV.
- Depending on the TV, noise or disturbance of the picture and/or sound may be generated if this unit is placed too close to your TV. In this case, please ensure enough space between your TV and this unit.
- Do not cover or place this unit in enclosed spaces to prevent excessive temperature build up.
- Do not place this unit in direct sunlight, or near heat sources.
- Depending on the environment, the temperature of this unit may increase slightly. This is not a malfunction.
- Keep this unit away from strong magnetic objects.
- Do not place any object containing water or other liquids on this unit. In the event that liquid should enter the cabinet, unplug this unit immediately and contact the retailer or an Authorized Service Center immediately.
- Do not remove this unit cabinet. Touching parts inside the cabinet could result in electric shock and/or damage to this unit. For service and adjustment inside the cabinet, call a qualified dealer or an Authorized Service Center.
- Be sure to remove disc and video tape and unplug the AC power cord from the output before carrying this unit.

Avoid the Hazards of Electrical Shock and Fire

- Do not handle the power cord with wet hands.
- Do not pull on the power cord when disconnecting it from AC wall outlet. Grasp it by the plug.
- If, by accident, water is spilled on this unit, unplug the power cord immediately and take the unit to our Authorized Service Center for servicing.
- Do not put your fingers or objects into the unit cassette holder.

Moisture Condensation Warning

Moisture may form inside this unit under the following conditions:

- Immediately after a heater is turned on.
- In a steamy or humid room.
- When this unit is suddenly moved from a cold to warm environment.

If moisture forms inside this unit, it may not operate properly or damage the video tape. In such case, turn on the power and wait for more than 2 hours for the moisture to evaporate.

About Copyright

Unauthorized copying, broadcasting, public performance and lending of discs are prohibited. This product incorporates copyright protection technology that is protected by U.S. patents and other intellectual property rights. Use of this copyright protection technology must be authorized by Macrovision, and is intended for home and other limited viewing uses only unless otherwise authorized by Macrovision. Reverse engineering or disassembly is prohibited.

Notice for Progressive Scan Outputs

Consumers should note that not all high definition television sets are fully compatible with this product and may cause artifacts to be displayed in the picture. In case of picture problems with 525 progressive scan output, it is recommended that the user switch the connection to the 'standard definition' output. If there are questions regarding your TV set compatibility with this 525p DVD player, please contact our customer service center.

Note to CATV system installer

This reminder is provided to call the CATV system installer's attention to Article 820-40 of the NEC that provides guidelines for proper grounding and, in particular, specifies that the cable ground should be connected to the grounding system of the building, as close to the point of cable entry as practical.

Symbols Used in This Manual

The following symbols appear in some headings in this manual.



: Description refers to playback or recording of video cassette tapes.



: Description refers to playback of DVD-Video discs.



: Description refers to playback of Audio CDs.



: Description refers to playback of MP3 files.

Maintenance

SERVICING

- Please refer to relevant topics on the "Troubleshooting Guide" on page 23 before returning the product.
- If this unit becomes inoperative, do not try to correct the problem by yourself. There are no user-serviceable parts inside. Turn off, unplug the power plug, and please call our help line mentioned on the front page to locate an Authorized Service Center.

CLEANING THE CABINET

- Use a soft cloth slightly moistened with a mild detergent solution. Do not use a solution containing alcohol, spirits, ammonia or abrasive.

CLEANING DISCS

- When a disc becomes dirty, clean it with a cleaning cloth. Wipe the disc from the center to out. Do not wipe in a circular motion.
- Do not use solvents such as benzene, thinner, commercially available cleaners, detergent, abrasive cleaning agents or antistatic spray intended for analog records.

CLEANING THE DISC LENS

- If this unit still does not perform properly although you refer to the relevant sections and to "Troubleshooting Guide" in this Owner's Manual, the laser optical pickup unit may be dirty. Consult your dealer or an Authorized Service Center for inspection and cleaning of the laser optical pickup unit.

DISC HANDLING

- When you handle a disc, hold it by its edge and try not to touch the surface of the disc.
- Always store the disc in its protective case when it is not used.

AUTO HEAD CLEANING

- Automatically cleans video heads as you insert or remove a cassette, so you can see a clear picture.
- Playback picture may become blurred or interrupted while the TV program reception is clear. Dirt accumulated on the video heads after a long period of use, or the usage of rental or worn tapes can cause this problem. If a streaky or snowy picture appears during playback, the video heads in your unit may need to be cleaned.

1. Please visit your local Audio/Video store and purchase a good quality VHS Video Head Cleaner.
2. If a Video Head Cleaner does not solve the problem, please call our help line mentioned on the front page to locate an Authorized Service Center.

Hint

- Remember to read the instructions along with the video head cleaner before use.
- Clean video heads only when problems occur.













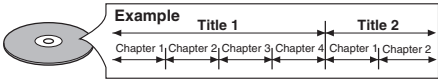

Manufactured under license from Dolby Laboratories. "Dolby" and the double-D symbol are trademarks of Dolby Laboratories.

About the Video Cassettes and Discs

Playable Video Cassettes

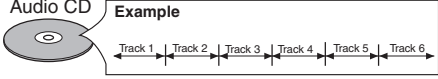
Use only cassettes marked  with this unit.

Playable Discs

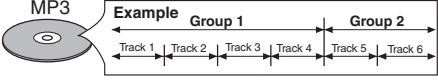
Playable discs	Mark (logo)	Region code	Recorded signals	Disc size	Disc types
DVD-Video *1, 2, 3, 5, 9		 or 	Digital video (MPEG2)	12 cm or 8 cm	
DVD-RW DVD-R *1, 3, 4, 5, 6, 8, 9, 10	   	—			
DVD+RW DVD+R *1, 3, 4, 5, 7, 8, 9, 10	 	—			
Audio CD *3, 5, 9		—	Digital audio or MP3	12 cm or 8 cm	
CD-RW CD-R *3, 4, 5, 8, 9	   	—			

 is a trademark of DVD Format/Logo Licensing Corporation.

If you cannot play back a disc which bears one of the marks above, check the following notes.

- *1: This unit conforms to the NTSC color system. Discs recorded in other color systems such as PAL cannot be played back.
- *2: Certain DVD-Video discs do not operate as described in this manual due to the intentions of the disc's producers.
- *3: Scratched or stained discs may not be played back.
- *4: Some discs cannot be played back because of incompatible recording conditions, characteristics of the recorder or special properties of discs.
- *5: You can play back discs which bear the marks above. If you use nonstandardized discs, this unit may not play them back. Even if they are played back, the sound or video quality will be compromised.
- *6: You may play back the unfinalized DVD-RW/R disc recorded in the video format on our brand's DVD recorder. However, depending on the recording status of a disc, the disc may not be played back at all or normally (the picture or sound may not be smooth, etc.). In this case, you need to finalize the disc with the DVD recorder. Refer to the manual accompanying the DVD recorder.
- *7: Only the discs recorded in the video format and finalized can be played back. Unfinalized discs cannot be played back. Depending on the recording status of a disc, the disc may not be played back at all the picture or sound may not be smooth, etc.
- *8: If the recorded portion of the disc is too small (less than 2 3/16 inches (55 mm) across), it may not play back properly.
- *9: Do not glue paper or put stickers on to the disc. These may damage the disc, and the unit may not read it correctly.
- *10: Discs Recorded in the VR (Video Recording) format cannot be played back.

Unplayable Discs

NEVER play back the following discs. Otherwise, malfunction may result!

DVD-RAM / DVD-Audio / CD-i / Photo CD / Video CD / DVD with region codes other than 1 or ALL / DTS-CD / DVD-ROM for personal computers / CD-ROM for personal computers

On the following disc, the sound MAY NOT be heard.

Super Audio CD

NOTE: Only the sound recorded on the normal CD layer can be delivered.

The sound recorded on the high density Super Audio CD layer cannot be delivered.

Any other discs without compatibility indications

Setup

Connections

Please refer to "Basic TV Connection" on the front page before you use this unit.

RF Output Channel

If channel 3 has been already occupied for broadcasting,

- 1) Set your TV to channel 4.
- 2) Insert a pre-recorded tape into this unit.
- 3) Press **[SOURCE]** on the unit so that the VCR SOURCE light is lit.
 - If noise appears on the TV screen, press **[VCR/TV]** on the remote control.
- 4) Press **[PLAY ▶]** once.

- 5) After a few seconds, press and hold **[PLAY ▶]** on the unit for 3 seconds.
 - The RF output channel will change to channel 4 from channel 3 and you will see a playback picture.
 - When a picture does not appear on the TV screen, repeat step 4.
- 6) Press **[STOP ■]** to stop playback.

Hint

- The RF output channel does not change when you adjust tracking during playback. In case RF output channel changes, you can easily switch it back just start the playback again then press and hold **[PLAY ▶]** on the unit for 3 seconds.

Hint for Cable Box or Satellite Box

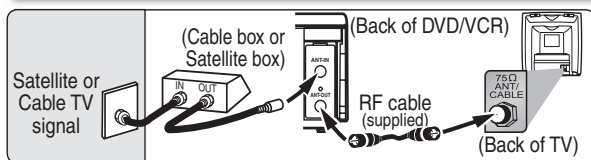

Select this connection when you want to view or record a scrambled channel. With this connection, channels cannot be changed on the unit. You can view or record ONLY the channels you have selected on the cable box or the satellite box.

- While you are recording, only the recorded channel can be viewed.

To select channels of the cable box or satellite box

- 1) Turn on the unit by pressing **[STANDBY-ON]**, then press **[VCR/TV]**. The POWER ON indicator on the front panel will light, then press **[SKIP/CH. ▶▶/▲, ◀◀/▼]** to select channel 3 or 4 (the same channel as the output channel of the cable box or satellite box).
 - If you use the channel 4, you need to change the unit's RF output to channel 4. Refer to "RF Output Channel".
- 2) At the TV, select channel 3 or 4 (the same channel as you have selected at step 1).
- 3) On the cable box or satellite box, select the channel you want to view or record.

Connection to an Audio System

Method 1

Stereo system

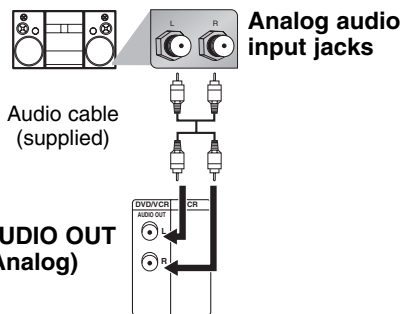

AUDIO OUT (Analog)

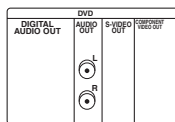

(DVD mode only)

Method 2

Dolby Digital decoder, MD deck or DAT deck

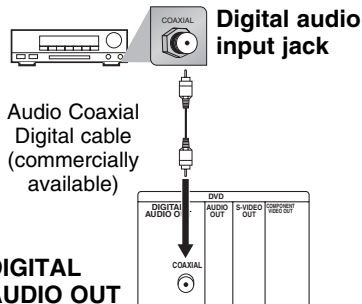

DIGITAL AUDIO OUT

Audio

DVD/VCR

Hint

- Playing a DVD using incorrect settings may generate noise distortion and may also damage the speaker.

Connection	Setting	SETUP > QUICK> DOLBY DIGITAL
Connecting to a Dolby Digital decoder for Dolby Digital audio output.		BITSTREAM
Connecting to the other equipment (an MD deck or DAT deck etc.) without Dolby Digital decoder.		PCM

* To complete these settings, refer to pages 20-21.

Hint

- The audio source on a disc in a Dolby Digital Multi channel surround format cannot be recorded as digital sound by an MD or DAT deck.
- By hooking this unit up to a Multi channel Dolby Digital decoder, you can enjoy high-quality Dolby Digital Multi channel surround sound as heard in the movie theaters.
- Playing a DVD using incorrect settings may generate noise distortion and may also damage the speakers.

Connection to a TV

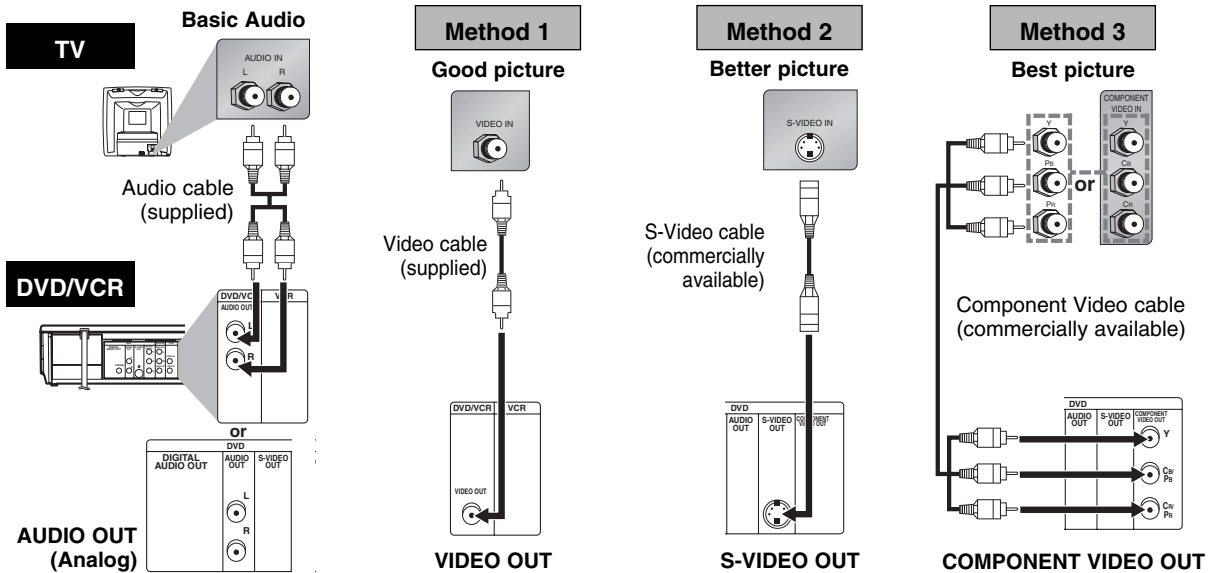

Hint

- Connect this unit directly to the TV. If the Audio/Video cables are connected to a VCR, pictures may be distorted due to the copy protection system.
- The COAXIAL, DVD AUDIO OUT, S-VIDEO OUT and COMPONENT VIDEO OUT jacks are only useful in DVD mode.

If your TV is compatible with 525 progressive scanning and you want to enjoy that high quality picture;

You must select the connection Method 3 above and progressive scanning mode. To set the mode, set "PROGRESSIVE" to "ON" in the SETUP menu, so that the P-SCAN indicator on the front panel lights on. See pages 20 to 21 for more details.

- When "PROGRESSIVE" is "ON", video signals from the unit's VIDEO OUT and S-VIDEO OUT jacks will be distorted or not be output at all.

If your TV is not compatible with progressive scanning;

Use this unit in interlace mode and set "PROGRESSIVE" to "OFF" either in the SETUP menu or by pressing and holding [PLAY ►] on the front of the unit for more than 5 seconds, so that the P-SCAN indicator on the front panel lights off.

After you have completed connections

Press the input selector button (usually TV/VIDEO, INPUT or AUX) on your TV to switch an appropriate external input channel (usually near channel 0) for viewing the picture from this unit. If the picture does not appear, also refer to the manual accompanying your TV.

INPUT MODES FOR COMMON TV BRANDS

Listed below are inputs for common brand name TV's.

Admiral:	AUX	Panasonic:	TV/VIDEO
Curtis Mathis:	LINE1, LINE2, 00, 90, 91, 92, 93	RCA:	INPUT, TV/VCR, 00, 90, 91, 92, 93
GE:	INPUT, TV/VCR, 00, 90, 91, 92, 93	Samsung:	TV/VIDEO
Hitachi:	INPUT, AUX	Sanyo:	VIDEO
JVC:	VIDEO, VIDEO1, VIDEO2, VIDEO3	Sharp:	00
Kenwood:	AUX	Sony:	VIDEO1, VIDEO2, VIDEO3
LXI-Series:	00	Toshiba:	TV/GAME
Magnavox:	AUX CHANNEL	Zenith:	00

Preparation for Use

Turn on the Unit for the First Time

 Operation described in this manual are mainly based on the remote control.

- Turn on the TV and set it to channel 3.
 - If channel 3 has been already occupied for broadcasting, see "RF Output Channel" section on page 6.



- Select your language in the first time you turn on this unit.

Then press **[▶]** to go to next step.

STANDBY-ON

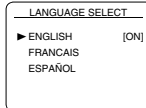
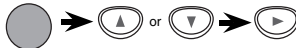

- Press **[▶]** to start Auto Set Up.

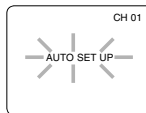

Do you connect the cable from the cable box or the satellite box to the unit's ANT-IN jack?

YES

NO

Yes Press **[MENU]** to exit.

• Refer to "Hint for Cable Box or Satellite Box" section on page 6.

No Please wait for a few minutes. After scanning...

- The tuner stops on the lowest memorized channel.
- You can select only the channels memorized in this unit by using **[SKIP/CH. ▶▶/▲, ◀◀/▼]** (or **[CHANNEL ▲/▼]**).
- If "AUTO SET UP" appears on the TV screen again, check the cable connections. Then, press **[▶]** once again.

Hint

- Repeat these steps only if either there was a power failure or this unit has been unplugged for more than 30 seconds.

To Select a Channel

You can select a channel by using the **Number buttons** or **[SKIP/CH. ▶▶/▲, ◀◀/▼]**.

Notes for using the Number buttons:

- When selecting cable channels which are higher than 99, enter channel numbers as a three-digit number. (for example: 117, press **[1]**, **[1]**, **[7]**)
- You must precede single-digit channel numbers with a zero. (for example: 02, 03, 04 and so on)

To Add or Delete Channels



- Press **[MENU]** to select "CHANNEL SET UP".

Then press **[▶]** to go to next step.

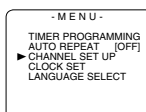
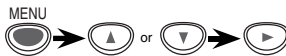

- If the clock is not set, the "CLOCK SET" screen appears when you press **[MENU]**. In this case, press **[MENU]** again.

- Select "MANUAL SET UP".

Then press **[▶]** to go to next step.

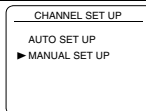

- Select the channel to be added or deleted.

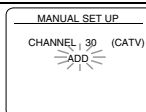
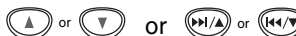

- Select "ADD" or "DELETE".

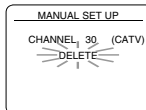
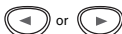

- To exit the menu



To Preset the Channel Again

- Press **[MENU]** until the main menu appears.
- Select "CHANNEL SET UP" by using **[▲/▼]**, then press **[▶]**.
- Select "AUTO SET UP" by using **[▲/▼]**, then press **[▶]**. After scanning, the tuner stops on the lowest memorized channel.

To Change the On-Screen Language

- Press **[MENU]** until the main menu appears.
- Select "LANGUAGE SELECT" by using **[▲/▼]**, then press **[▶]**.
- Select "ENGLISH", "FRANCAIS" or "ESPAÑOL" by using **[▲/▼]** then press **[CLEAR/C.RESET]**.

Hint

- If you accidentally select Spanish or French and need English: Press **[MENU]** and choose SELEC. IDIOMA or SELECTION LANGUE. Press **[▶]** and select ENGLISH. Finally, press **[CLEAR/C.RESET]**.
- To add or delete channels in this unit, **[SKIP/CH. ▶▶/▲, ◀◀/▼]** button works on the channel number memorized in this unit, **[▲/▼]** works on all.

Clock Setup



- Press **[MENU]** and select "CLOCK SET".

Then press **[▶]** to go to next step.

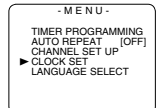

- If the clock is not set, the "CLOCK SET" screen appears when you press **[MENU]**. In this case, go to step 2.

- Select the current month.

Then press **[▶]** to go to next step.

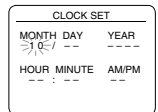

- Select the current day.

Then press **[▶]** to go to next step.

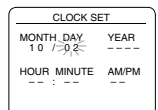

- Select the current year.

Then press **[▶]** to go to next step.

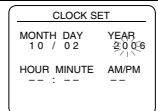

- Select the current hour.

Then press **[▶]** to go to next step.

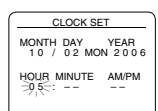

- Select the current minute.

Then press **[▶]** to go to next step.

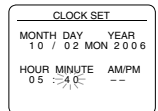

- Select "AM" or "PM".

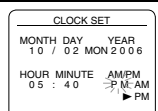
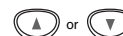

- To exit the CLOCK SET screen



Hint

- To go back one step, press **[◀]** (during steps 2 to 7).
- Your clock setting will be lost if either there is a power failure or this unit has been unplugged for more than 30 seconds.

Function Overview

Front Panel Indicator

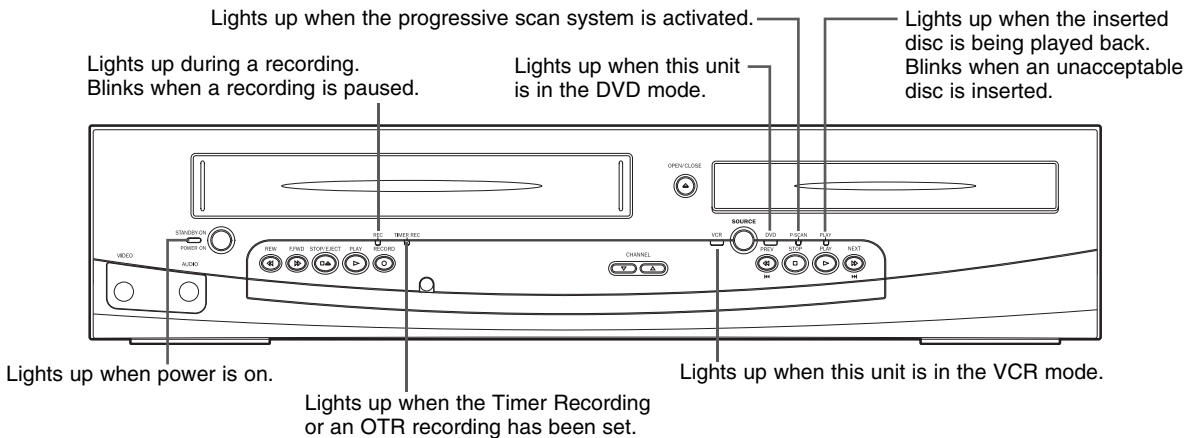

VCR / DVD Switching

You must select which component you wish to operate with [SOURCE] at first, as this product is a combination of a VCR and a DVD player.

VCR MODE

Press [VCR] on the remote control.
(Verify that the VCR SOURCE light is lit.)

DVD MODE

Press [DVD] on the remote control.
(Verify that the DVD SOURCE light is lit.)

Hint

• Pressing only [SOURCE] on the front panel DOES NOT switch the mode of the remote control. You MUST select the correct mode on the remote control.

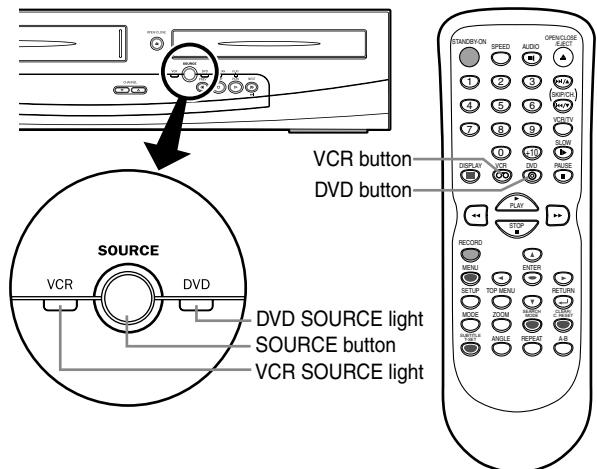

Front & Rear Terminals

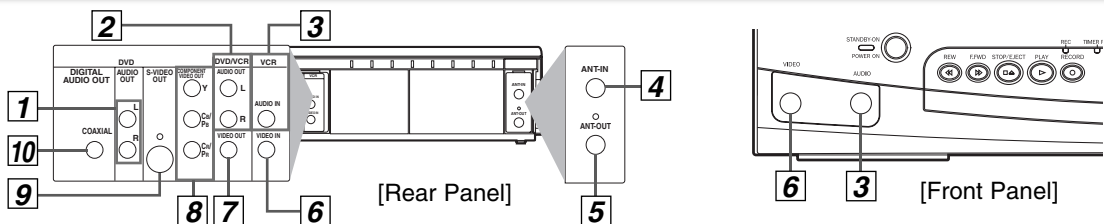

1: DVD AUDIO OUT (analog) jacks

Connect the supplied audio cable here through the audio in jacks of a television or other audio equipment. (DVD only)

2: DVD/VCR AUDIO OUT jacks

Connect the supplied audio cable here through the audio in jacks of a television or other audio equipment.

3: AUDIO IN jack

Connect audio cable coming from the audio out jack of a camcorder, another VCR or an audio source here.

4: ANT-IN jack

Connect your antenna or cable box here.

5: ANT-OUT jack

Connect the supplied RF cable to the antenna input jack of a television.

6: VIDEO IN jack

Connect a cable coming from the video out jack of a camcorder, another VCR or an audio-visual source (laser disc player, video disc player, etc.) here.

7: DVD/VCR VIDEO OUT jack

Connect the supplied video cable here through the video in jack of a television.

8: COMPONENT VIDEO OUT jacks

Connect optional COMPONENT VIDEO cables here through the COMPONENT VIDEO in jacks of a television. (DVD only)

9: S-VIDEO OUT jack

Connect an optional S-VIDEO cable here through the S-VIDEO in jack of a television. (DVD only)

10: DIGITAL AUDIO OUT COAXIAL jack

Connect an optional coaxial digital audio cable here through the coaxial digital audio in jack of a decoder or audio receiver. (DVD only)

Remote Control

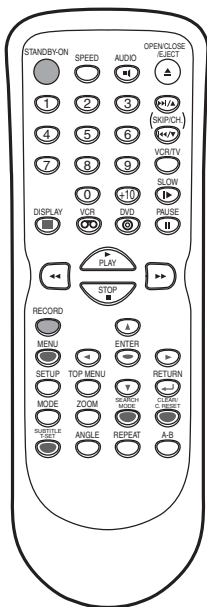

Installing the Batteries for the Remote Control

Install two AA batteries (supplied) matching the polarity indicated inside battery compartment of the remote control.

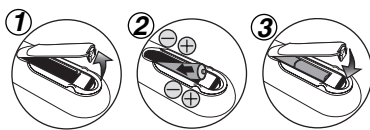

Keep in mind the following when using the remote control:

- Make sure that there is no obstacle between the remote control and the remote sensor on the unit.
- The maximum operable ranges from the unit are as follows.
 - **Line of sight:** approx. 23 feet (7m)
 - **Either side of center:** approx. 16 feet (5m) within 30°
 - **Above:** approx. 16 feet (5m) within 15°
 - **Below:** approx. 10 feet (3m) within 30°

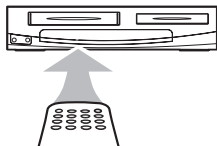

Hint

- Do not mix alkaline and manganese batteries.
- Do not mix old and new batteries.

Button (Alphabetical order)	DVD mode		VCR mode
	DVD	CD MP3	VHS
1 2 3 4 5 6 7 8 9 0	• To select chapter or title directly.	• To select track directly.	• To select channel. • The +10 button has no effect in VCR mode.
◀ ▶	• To search forward/backward through a disc. • To begin slow forward/reverse playback in the pause mode.	• To search forward/backward through a disc.	• To forward/backward a tape.
A-B	• To repeat between your chosen point A and B.	• To repeat between your chosen point A and B. (CD)	—
ANGLE	• To select camera angles on a disc.	—	—
AUDIO	• To select audio languages on a disc.	• To select STEREO, L-ch or R-ch. (CD)	—
CLEAR C/RESET	• To clear the markers. • To clear the numbers entered incorrectly. • To cancel the point for A-B repeat.	• To clear the markers. (CD) • To remove status number in program input. • To clear the numbers entered incorrectly. • To cancel the point for A-B repeat. (CD)	• To exit the VCR Menu. • To reset the tape counter.
DISPLAY	• To display the current disc mode.	• To display the current disc mode.	• To display the current time, tape counter, and channel.
DVD	• To select the DVD output mode. • To activate the remote control in DVD mode.	• To select the DVD output mode. • To activate the remote control in DVD mode.	—
ENTER	• To move the cursor and determine its position.	• To move the cursor and determine its position.	• To select an item on the VCR Menu. • To advance to the next VCR Menu. • To go back one step during clock and timer setting.
MENU	• To call up the Menu on a disc.	• To call up the file list. (MP3)	• To call up the VCR Menu.
MODE	• To set black level on/off. • To set virtual surround on/off.	• To arrange the playing order or play randomly. • To set virtual surround on/off.	—
OPEN/CLOSE EJECT	• To open or close the disc tray.	• To open or close the disc tray.	• To eject the video cassette from the VCR.
PAUSE	• To pause disc playback. • To advance playback one frame at a time.	• To pause disc playback.	• To pause tape playback or recording. • To advance playback one frame at a time.
PLAY	• To begin disc playback.	• To begin disc playback.	• To begin tape playback.
RECORD	—	—	• To start a recording or One Touch Recording.
REPEAT	• To play a chapter or title repeatedly.	• To play a track or disc repeatedly. (CD) • To play a track, group or disc repeatedly. (MP3)	—
RETURN	• To return to the previous operation in menu.	• To return to the previous operation in menu.	—
SEARCH MODE	• To search chapter, title or time. • To set or search the markers.	• To search track. • To search time. (CD) • To set or search the markers. (CD)	• To call up the index or time search menu.
SETUP	• To call up the DVD setup menu.	• To call up the DVD setup menu.	—
SKIP/CH. SKIP/CH.	• To skip chapters or titles.	• To skip tracks.	• To change channels. • To adjust the tracking manually during playback.
SLOW	—	—	• To view the tape in slow motion.
SPEED	—	—	• To select the recording speed.
STANDBY-ON	• To turn the unit on/off.	• To turn the unit on/off.	• To turn the unit on/off.
STOP	• To stop playback.	• To stop playback.	• To stop playback or recording.
SUBTITLE T-SET	• To select subtitles on a disc.	—	• To put the VCR into standby mode for a Timer Recording.
TOP MENU	• To call up the Top Menu on a disc.	• To return to the top file of the highest hierarchy in the program and file list. (MP3)	—
VCR	—	—	• To select the VCR output mode. • To activate the remote control in VCR mode.
VCR/TV	• To select DVD position or TV position.	• To select CD/MP3 position or TV position.	• To select VCR position or TV position.
ZOOM	• To magnify part of a picture. (x2/x4)	—	—

VCR Functions

Playback

Before:

Turn on the TV and set it to channel 3.

• If channel 3 has been already occupied for broadcasting, see "RF Output Channel" section on page 6.



1 Insert a video cassette into this unit. 	2 To start playback
3 To stop playback 	4 To eject the cassette

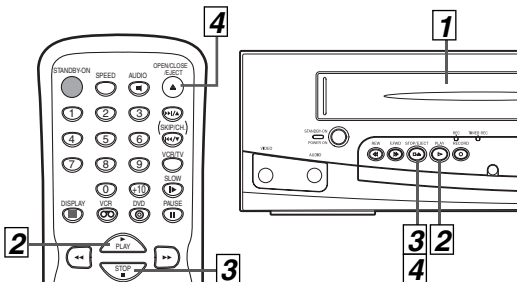

Hint

- When a tape without record tab is inserted, the unit will start playback automatically.
- Tracking will be automatically adjusted upon playback. To adjust the tracking manually, press [SKIP/CH. ▶▶/▲, ◀◀/▼] (or [CHANNEL ▲/▼]).

Other Operations

To cue or review picture during playback (Picture Search)

Use [▶▶] or [◀◀]([F.FWD ▶▶] or [REW ◀◀]).

• Press it again and the unit will search in super high speed. (in the SLP mode only)

To freeze the picture on TV screen during playback (Still mode)

Press [PAUSE ■]. Each time you press the button, the picture will be forwarded by one frame.

- If the picture begins to vibrate vertically in the still mode, stabilize the picture by using [SKIP/CH. ▶▶/▲, ◀◀/▼] (or [CHANNEL ▲/▼]).
- If the picture is distorted or rolling vertically, adjust the vertical hold control on your TV if equipped.

Hint

- Still/Slow mode will be automatically canceled after 5 minutes to prevent damage to the tape and the video head.
- To return to playback from the Picture Search/Still/Slow mode, press [PLAY ▶].

Counter Reset

Press [CLEAR/C.RESET].

To play back in slow motion (Slow mode)

Press [SLOW] during playback or the still mode.

• If the noise bars appear on the TV screen, you can reduce it by using [SKIP/CH. ▶▶/▲, ◀◀/▼] (or [CHANNEL ▲/▼]).

Auto Rewind

When a tape reaches its end during playback, fast-forward or recording (except Timer Recording and One Touch Recording), the tape will automatically rewind to the beginning. After rewinding finishes, the unit will eject the tape.

VCR Functions

Index Search

You can skip the program backward and forward by the Index Mark.



• Insert a tape into this unit.

1 Press [SEARCH MODE] once.



2 To select Index Mark

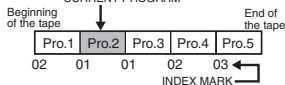
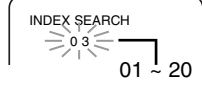
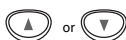

3 To rewind



To fast forward



4 After searching, it automatically starts playback.



Hint

- The Index Mark will be made automatically at the beginning of each recording.
- The time gap between Index Marks should be greater than 1 minute for SP mode, 2 minutes for LP mode and 3 minutes for SLP mode.

Time Search

You can search backward and forward a specific length of time on a tape.



• Insert a tape into this unit.

1 Press [SEARCH MODE] twice.



2 Select the desired length of time for fast forwarding or rewinding.

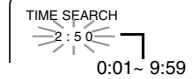
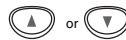

(1 minute~9 hours and 59 minutes)

3 To rewind



To fast forward



4 After searching, it automatically starts playback.



Hint for Index Search & Time Search

- These functions are not available during recording.
- Press [STOP ■] to stop the search.
- If a tape ends during a search, your search will be canceled and the tape will rewind to the beginning.

Auto Repeat

This function will playback a tape repeatedly from the beginning when the tape reaches the end.



- 1 Press [MENU], and choose "AUTO REPEAT" during playback.

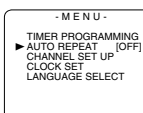

- 2 Press [▶] for "AUTO REPEAT", "ON" or "OFF".

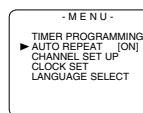

Hint

- To cancel Auto Repeat, follow step 1 above. Then, press [▶] so that "OFF" appears beside "AUTO REPEAT". Press [CLEAR/C.RESET] to exit.
- If menu remains on the TV screen after step 2, press [CLEAR/C.RESET] to exit.
- The Auto Repeat playback will start automatically if you select "AUTO REPEAT" to "ON" in the stop mode.

Recording

Recording & OTR (One Touch Recording)

Before: Turn on the TV and set it to channel 3.

- If channel 3 has been already occupied for broadcasting, see "RF Output Channel" section on page 6.



- 1 Insert a cassette with tab into this unit.



- 2 Select the channel to record.

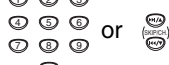

- 3 Press [SPEED] to select the desired tape speed.



Tape Speed	Recording/Playback Time		
Type of tape	T160	T120	T160
SP mode	1hour	2hours	2-2/3hours
SLP mode	3hours	6hours	8hours

- 4 Press [RECORD] repeatedly to select the desired recording length.



- 5 To stop recording



- 6 To eject the recorded cassette

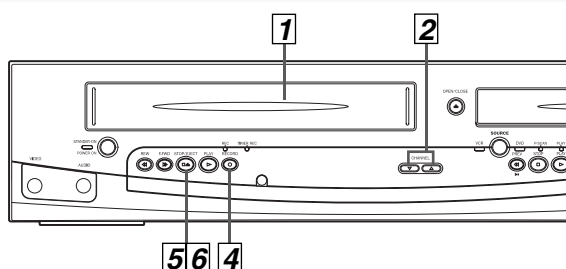
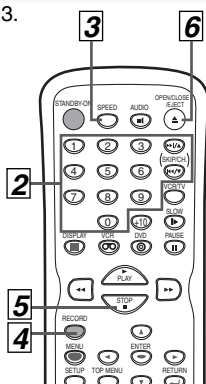

Accidental erasure prevention

To prevent accidental recording on a recorded cassette, remove its record tab. To record on it later, cover the hole with adhesive tape.

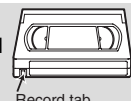

You **CAN NOT** dub a DVD to a videotape.

To stop recording temporarily (Pause mode)

Press [PAUSE II].

- During the rec-pause mode, five ■ marks appear on the TV screen. Each ■ mark represents one minute.
- Press it again to resume recording.
- Pause mode will be automatically canceled after 5 minutes to prevent damage to the tape and the video head.

Hint

- If you want to watch one channel while recording another...
 - 1) Press [VCR/TV] to put the unit in TV position.
 - 2) Select a channel you want to watch with the cable box or the satellite box.

Timer Recording



• Insert a tape with its record tab into the unit.

- 1 Press [MENU], then select "TIMER PROGRAMMING".

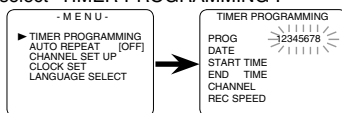
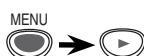

Available program number flashes.

- 2 Select an empty program number. Then press [▶] to go to next step.

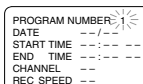

- 3 Select "ONCE", "DAILY" (Mon-Fri), or "WEEKLY". Then press [▶] to go to next step.

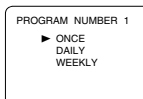

- 4 Select the desired date. Then press [▶] to go to next step.

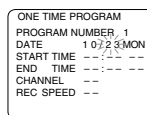
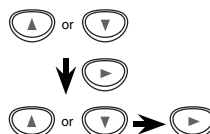

- You can set a program one year in advance.

- 5 Select the desired start time (hour). Then press [▶] to go to next step.

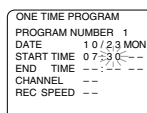
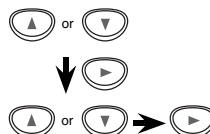

- 6 Select "AM" or "PM".
Then press **[▶]** to go to next step.

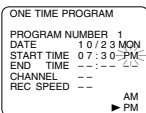

- 7 Repeat the procedure in steps 5 and 6 to set the end time.



- 8 Select the desired channel.
Then press **[▶]** to go to next step.

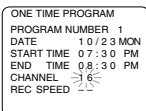

- If you have connected the unit to a cable box or satellite box as the connection on page 6, select the VCR to channel 3 or 4 (the RF output channel of the VCR). Then, select the desired channel at the cable box or satellite box. Leave the cable box or satellite box on for Timer Recording.

- 9 Select the desired recording speed, then press **[CLEAR/C.RESET]**.

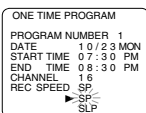

- To set another program after step 9, press **[▶]**. Then, continue with step 2.

- 10 Press **[SUBTITLE/T-SET]** to set timer standby mode.



- TIMER REC indicator on the front panel lights up. The unit will change to the DVD mode.

Hint

- To go back one step, press **[◀]** during steps 3 to 9.

To Check, Correct or Cancel a Timer Program

- 1) Press **[SUBTITLE/T-SET]** then, **[VCR]** on the remote control.
- 2) Select main menu by pressing **[MENU]**.
- 3) Select "TIMER PROGRAMMING" by using **[▲/▼]**, then press **[▶]**.
- 4) Select the program number which you want to check by using **[▲/▼]**. The details of the program you selected will appear on the TV screen.
 - Go to the digit you want to change by using **[◀▶]**. Then, enter correct numbers by using **[▲/▼]**.
 - You may cancel the entire program by pressing **[◀]** while the program number blinks.
- 5) Press **[CLEAR/C.RESET]** to exit.
- 6) Press **[SUBTITLE/T-SET]** to return to timer standby mode.

To cancel a Timer Recording in progress

Press **[STOP/EJECT ■ ▲]** on the unit.

Hints for OTR and Timer Recording

- Press **[VCR]** on the remote control before you set Timer Recording. Make sure the remote control is in the VCR mode, then press **[SUBTITLE/T-SET]**.
- If a tape is not in the unit or does not have the record tab, TIMER REC indicator on the front panel blinks and Timer Recording cannot be performed. Please insert a recordable tape.
- When Timer Recordings are set, TIMER REC indicator on the front panel lights up. To use the VCR as usual until the time for the recording, press **[SUBTITLE/T-SET]** so that TIMER REC indicator lights off. Press **[VCR/TV]** to choose the VCR position. Select either VCR or DVD mode, then continue with the other features as described in this manual.

After an OTR or a Timer Recording has been set, this unit operates as follows:

- If a tape runs out before an OTR or a Timer Recording is finished, the unit ejects the tape. Press **[SUBTITLE/T-SET]** on the remote control or **[STOP/EJECT ■ ▲]** on the unit, then press **[VCR]** to activate the VCR function again.
- Once the unit turns to the timer standby mode, no VCR functions are available until **[SUBTITLE/T-SET]** is pressed.
- To cancel the timer standby mode, press **[SUBTITLE/T-SET]** on the remote control or **[STOP/EJECT ■ ▲]** on the unit, then press **[VCR]** to activate the VCR function again.
- The mode of the unit and the remote control may differ (VCR mode or DVD mode) when you set Timer Recording or after you canceled Timer Recording. Press **[VCR]** or **[DVD]** on the remote control to select your desired mode before you operate.

When an OTR or a Timer Recording is completed...

- If Auto Power Off for DVD has been activated and there are Timer Recordings on standby, the unit turns off automatically, and TIMER REC indicator on the front panel lights to indicate the unit is in the timer standby mode.
- TIMER REC indicator on the front panel flashes if there are no more Timer Recordings on standby.
- If Auto Power Off for DVD has NOT been activated, the unit switches to the DVD mode and all the VCR functions will be unavailable. All the DVD functions are available during OTR, timer standby mode and Timer Recording.
- Press **[STOP/EJECT ■ ▲]** on the front panel or **[SUBTITLE/T-SET]** on the remote control to use the VCR when the unit is off.
- Press **[SOURCE]** on the front panel or **[VCR]** on the remote control to use the VCR when the unit is on. In case Timer Recording is in standby mode, press **[STOP/EJECT ■ ▲]** on the front panel or **[SUBTITLE/T-SET]** on the remote control, and then press **[SOURCE]** on the front panel or **[VCR]** on the remote control.

If you want to use the DVD player during a Timer Recording or while TIMER REC indicator on the front panel is on or blinking.

- Press **[STANDBY-ON]** to turn on the unit. Press **[DVD]** on the remote control to choose DVD mode, then continue with the other DVD features as described in this manual.

NOTE (for Timer Recording) :

- If there is a power failure or the unit is unplugged for more than 30 seconds, clock and all timer settings will be lost.

Copying a Video Tape

Warning: Unauthorized recordings of copyrighted video tapes may be an infringement of copyright laws.

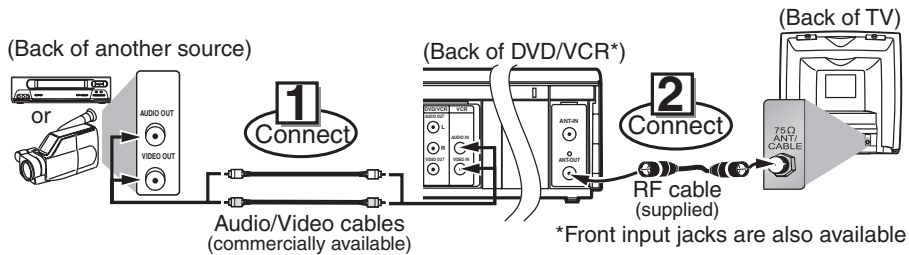

- 1) Insert a pre-recorded tape into another VCR for playing.
- 2) Insert a tape with its record tab into this unit for recording.
- 3) Press **[SPEED]** on the remote control of the recording unit to select the desired recording speed (SP/SLP).
- 4) Select the "L1" or "L2" position on the recording unit.
 - To use the input jacks on the back of this unit, select "L1" position by pressing **[0], [0], [1]** on the remote control or **[CHANNEL ▲/▼]** on this unit.
 - To use the input jacks on the front of this unit, select "L2" position by pressing **[0], [0], [2]** on the remote control or **[CHANNEL ▲/▼]** on this unit.
- 5) Press **[RECORD]** on the recording unit.
- 6) Begin playback of the tape in another source.
- 7) To stop recording, press **[STOP/EJECT ■ ▲]** on the recording unit, then stop playback of the tape in another source.

Hint

- For best results during dubbing, use the front panel controls whenever possible. The remote control might affect another source's operation.
- Always use video-quality shielded cables with RCA-type connectors. Standard audio cables are not recommended.
- You can use a video disc player, satellite receiver or other audio/video component with Audio / Video outputs.
- "L1" or "L2" is found before the lowest memorized channel. (Example: CH02)
- "L2" input jacks are on the front of this unit.

DVD Functions

Playback

Before: Turn on the TV, amplifier and any other components which are connected to this unit. Make sure the TV and audio receiver (commercially available) are set to the correct channel.



<p>1</p> <p>STANDBY-ON</p> <p>OPEN/CLOSE/SELECT</p>	<p>2 Insert a disc with label facing up.</p>
<p>3 To start playback</p> <p>PLAY</p>	<p>4 To stop playback</p> <p>STOP</p>

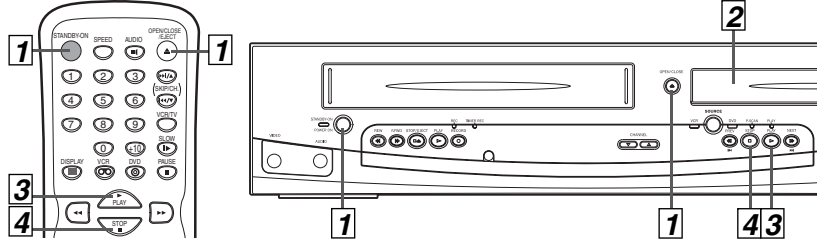

Hint

- When you play an MP3 file, details on page 16.
- A "prohibited icon" may appear at the top-right on the TV screen when the operation is prohibited by the disc or this unit.
- Some DVDs may be played from title 2 or 3 due to specific programs.
- **During the playback of a two-layered disc, pictures may stop for a moment. This happens while the 1st layer is being switched to the 2nd layer. This is not a malfunction.**

TIP:

You can change the on-screen language for DVD function in "PLAYER MENU" setting. (Refer to page 20.)

DVD menu

Some discs contain menus which allow you to customize DVD playback. Press [▲/▼/◀/▶] to select an item, then press [ENTER] (or [PLAY ▶]).

Calling up a Menu Screen during Playback

- Press [MENU] to call up the DVD menu.
- Press [TOP MENU] to call up the title menu.

Hint

- Menu operations may vary depending on the disc. Refer to the manual accompanying the disc for details.

Resume



Press [STOP ■] during playback. Resume message will appear on the TV screen. Press [PLAY ▶], playback will resume from the point at which playback was stopped.

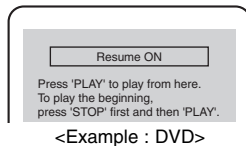

Hint

- To cancel resume, press [STOP ■] one more time in the stop mode.
- For MP3, playback will resume from the beginning of the track at which playback was stopped.
- The resume information stays on even when the power is turned off.

Paused and Step-by-Step Playback



Press [PAUSE II] during playback. To continue playback, press [PLAY ▶].



The disc goes forward by one frame each time [PAUSE II] is pressed in the pause mode. To continue playback, press [PLAY ▶].

Hint

- On DVDs, set "STILL MODE" to "FIELD" in the DISPLAY menu if pictures in the pause mode are blurred. (Refer to pages 20-21.)

To use [PREV ◀◀/◀], [NEXT ▶▶/▶] on this unit



Press once to skip chapters or tracks to a desired point.

Fast Forward / Reverse Search



Press [◀◀] or [▶▶] repeatedly during playback to select the required forward or reverse speed.

To use [PREV ◀◀/◀], [NEXT ▶▶/▶] on this unit

Pressing and holding [PREV ◀◀/◀] or [NEXT ▶▶/▶] on this unit will also change forward or reverse playback speed.

To continue playback, press [PLAY ▶].

Hint

- For DVDs, fast forward or reverse search speed is different depending on the disc. Approximate speed is 1(x2), 2(x8), 3(x20), 4(x50), 5(x100).
- For Audio CDs and MP3, approximate speed is 1(x2), 2(x8), 3(x30).

Slow Forward / Reverse



Press [◀◀] or [▶▶] repeatedly in the pause mode to select the required forward or reverse speed.

To use [PREV ◀◀/◀], [NEXT ▶▶/▶] on this unit

Pressing and holding [PREV ◀◀/◀] or [NEXT ▶▶/▶] on this unit in the pause mode will also change forward or reverse playback speed.

To continue playback, press [PLAY ▶].

Hint

- Slow forward or reverse speed is different depending on the disc. Approximate speed is 1(1/16), 2(1/8), 3(1/2).
- Set "STILL MODE" to "FIELD" in the DISPLAY menu if pictures in the slow playback mode are blurred. (Refer to pages 20-21.)

Zoom



- 1) Press [ZOOM] during playback.
- 2) Press [ZOOM] repeatedly to select the required zoom factor: x2, x4 or OFF.



- 3) Press [▲/▼/◀/▶] to slide the zoomed picture across the screen.
- 4) To exit zoom mode, press [ZOOM] to select OFF.

Hint

- Zooming function does not work while the disc menu is showing up.
- x4 zoom is not available on some discs.
- The picture may be distorted when you press [PAUSE II] or [◀◀] repeatedly in the zoom mode.
- In the zoom mode, it automatically changes [x2(x4)] to the zoomed position guide.

MP3 Playback

MP3 is a method of compressing files. You can copy MP3 files on CD-R/RWs from the computer and play the files on this unit.



Insert an MP3-format disc, then the file list will automatically appear on the TV screen. Press [MENU] when you want to call up the file list again while MP3-format disc is already inserted.

1 When selecting the folder:

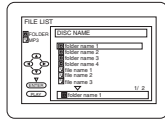

- Press [▶] when you want to go to the next hierarchy.
- Press [◀] when you want to go back to the previous hierarchy (except for the top hierarchy).

2 To cancel MP3 playback, press [STOP ■].



Refer to "Resume" on page 15.

Hint

- Some selections may take a while to be recognized.
- Press [TOP MENU] to return to the first item.
- Folders are known as Groups; files are known as Tracks.
- Folders and MP3 are displayed respectively as [] and [].
- A maximum of 255 folders or 999 files may be recognized in one disc.
- Up to 8 hierarchies can be recognized in one folder. File in the 9th or deeper hierarchies cannot be played back.

This player recommends the files recorded under the following circumstances:

- Sampling frequency: 44.1kHz or 48kHz
- Constant bit rate: 32kbps ~ 320kbps
- For MP3 file recorded in Variable Bit Rate(VBR), the unit may not display the actual elapsed time.

On-Screen Display

You can check the information about the current disc by pressing [DISPLAY] on the remote control.

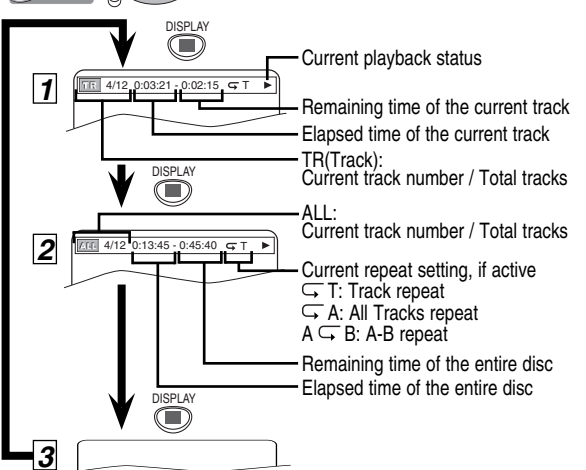
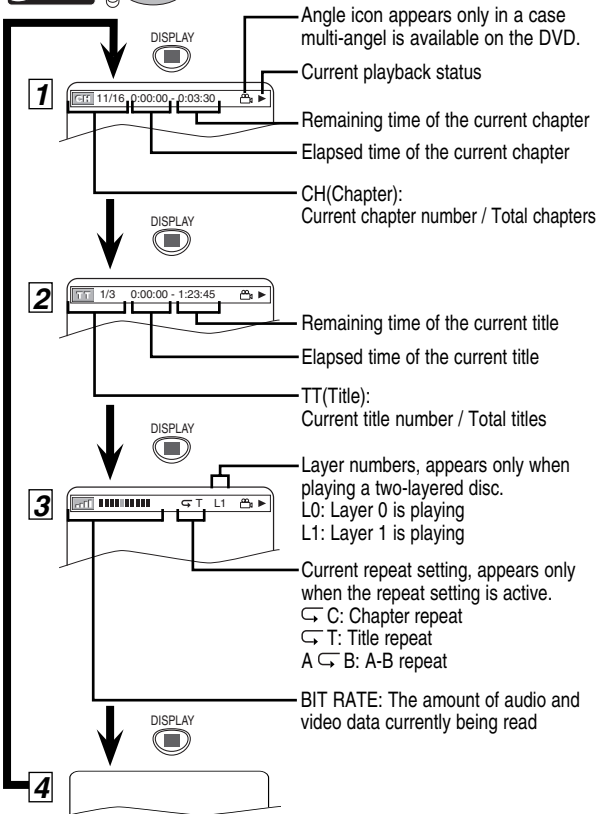

Hint

- When you are playing a disc in PROGRAM or RANDOM mode, [PROGRAM] (or [RANDOM]) will be displayed instead of [2].

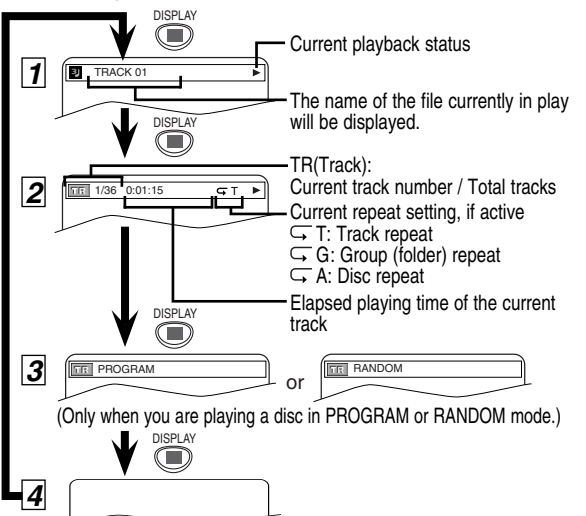

Search Functions

SEARCH MODE does not work during Programmed or Random Playback.

Using Track Search



1 Press [SEARCH MODE].

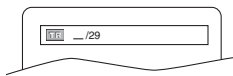

2 Select track number by using the Number buttons within 30 seconds.

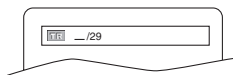
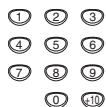

- For the disc with less than 10 tracks, press the track number directly.
- For discs with more than 10 but less than 99 tracks, to play single-digit track, press [0] first, then the track number (e.g. for track 3, press [0], [3]). To play a double-digit track, press the track number.
- For discs with more than 100 tracks, to play a single or a double-digit track, press [0] first, then the track number (e.g. for track 3, press [0], [0], [3], and for track 26, press [0], [2], [6]). To play a triple-digit track, press the track number.

Using [SKIP/CH. >>>/<<<, <<</>>>]

1 Press [SKIP/CH. >>>/<<<, <<</>>>] during playback.



Hint

- [+10] can also bring the Track search display, except for the disc with less than 10 tracks. For such a disc, track search can be done by just pressing the track number.
- For Audio CDs and MP3, Track Search is not available for Program and Random Playback.

Using Title / Chapter Search



1 Press [SEARCH MODE] once for the Chapter Search.
Press [SEARCH MODE] twice for the Title Search.

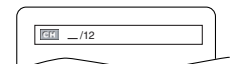
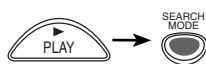

2 Select title/chapter number by using the Number buttons within 30 seconds.

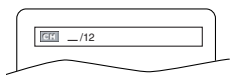
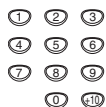

Using [SKIP/CH. >>>/<<<, <<</>>>]

1 Press [SKIP/CH. >>>/<<<, <<</>>>] during playback.

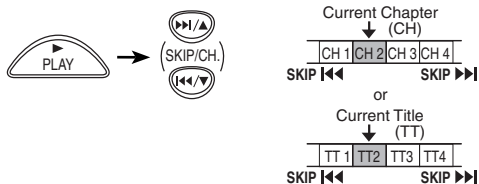

(If the disc has no chapters)

Hint

- Depending on the disc being played, this function can also be performed by directly entering the desired chapter number with the Number buttons. Refer to the manual accompanying the disc.

Using Time Search



1 Press [SEARCH MODE] repeatedly until the Time Search display appears.

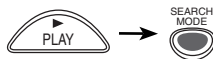

2 Select a desired disc time by using the Number buttons within 30 seconds.

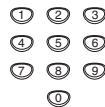

Hint

- When there is no need to enter a number, "0" appears automatically. For example, "0:0:_" appears in the Time Search display if the total time of the title or track is less than 10 minutes.
- Press [CLEAR/C.RESET] to erase the incorrect input at step 2.

Marker Setup



This feature allows you to assign a specific point on a disc to be called back later.

To set a marker

1 Press [SEARCH MODE] repeatedly until the marker display appears.

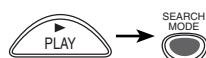

2 Select a marker.



3 Press [ENTER].

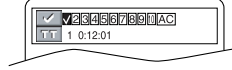

To return to the marker later

1 Press [SEARCH MODE] repeatedly until the marker display appears.

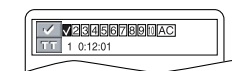

2 Select the marker.

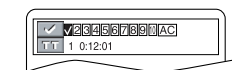

3 Press [ENTER] at the desired marker.

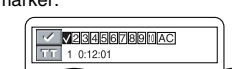

To exit the marker screen

1 Press [RETURN].



Hint

- The Marker display will disappear in about 30 seconds when there is no output.
- To clear a marker, select the marker to be cleared at step 2 in the section "To set a marker" or "To return to the marker later" and then press [CLEAR/C.RESET].
- Opening the disc tray or turning off the power will erase all markers.
- Selecting "AC" at step 2 in the section "To set a marker" or "To return to the marker later" will also erase all markers.

Repeat / Random / Programmed Playback

Repeat Playback



Repeat function is available only during playback.

- 1 Press [REPEAT] during playback.



Each time you press [REPEAT] repeat function changes as example below.

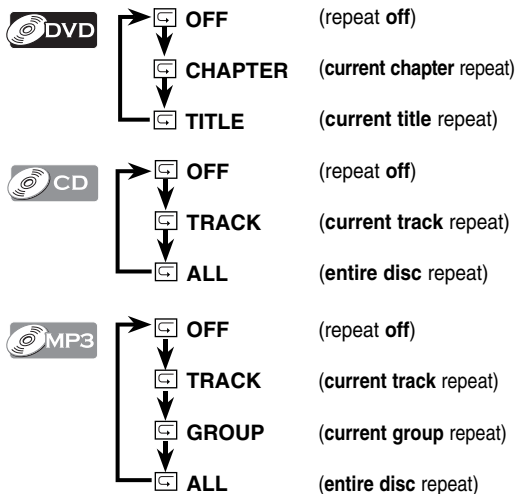

Hint

- Repeat setting (except "ALL") will be cleared when moving to another title, chapter, track or group.
- Repeat playback are not available with some discs or during repeat A-B playback.

Repeat A-B Playback



Repeat function is available only during playback.

- 1 Press [A-B] at your desired starting point (A).



- 2 Press [A-B] at your desired ending point (B).



- Point B should be in the same title or track as point A.

Hint

- To exit the sequence, press [A-B] so that "OFF" appears.
- To cancel point A, press [CLEAR/C.RESET] at step 1.
- This function does not work in the other repeat modes.

Random Playback



This function shuffles the playing order of tracks instead of playback in the sequence.

- 1 Press [MODE] twice.



- 2 Press [PLAY ▶] to start Random Playback.

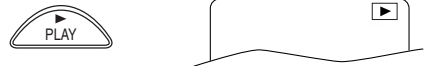

Hint

- To repeat the current track in the random selections, press [REPEAT] repeatedly until "TRACK" appears during playback.
- To repeat the entire random selections, press [REPEAT] repeatedly until "ALL" appears during playback.
- During random playback, you cannot go back to the previous track.

Programmed Playback



You may determine the order in which tracks will play.

- 1 Press [MODE] once.

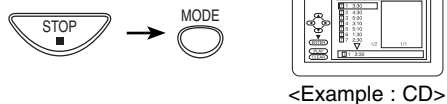

- 2 Using [▲/▼] to select desired track. Press [ENTER].



- Up to 99 tracks can be ordered.
- If eight or more tracks were in a program, use [SKIP/CH. ▶▶/▲, ◀◀/▼] to see all the tracks.
- While an MP3 folder is open:
 - Press [▶] when you want to go to the next hierarchy.
 - Press [◀] when you want to go back to the previous hierarchy (except for the top hierarchy).

- 3 Press [PLAY ▶] to start Programmed Playback.



Hint

- Press [CLEAR/C.RESET] at step 2 to erase the most recently entered track.
- To erase all programmed tracks at once, select "ALL CLEAR" and press [ENTER] at step 2.
- While a program is being played back, [STOP ■] works as follows:
 - ⇒ Press [STOP ■] and [PLAY ▶] next, so that the programmed playback restarts. (CD playback restarts from the current point. MP3 playback restarts from the beginning of the current track.)
 - ⇒ Press [STOP ■] twice and [PLAY ▶] next, so that playback restarts from the first track in the original order. However, your programmed playback can be restarted when you follow the above steps. (Your programs are still stored until either the disc tray is open or power is turned off.)
- To repeat the current track in the program, press [REPEAT] repeatedly until "TRACK" appears during playback.
- To repeat the entire program, press [REPEAT] repeatedly until "ALL" appears during playback.

Special Settings

Subtitle Language



This unit allows you to select a subtitle language (if available) during DVD playback.

- 1 Press **[SUBTITLE/T-SET]** during playback.



Each time you press **[SUBTITLE/T-SET]**, subtitle language changes as example below.

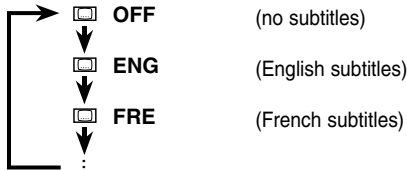

To set subtitle ON/OFF

- 1 Press **[SUBTITLE/T-SET]** during playback.



- 2 Press **[▶]** to select subtitle ON or OFF.

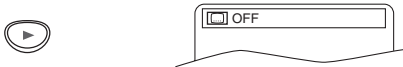

Hint

- If your language is not shown after pressing **[SUBTITLE/T-SET]** several times, the disc may not have that language. However, some discs allow subtitle language setting on the disc menu. (Operation varies depending on the discs, so refer to the manual along with the disc.)
- When "NOT AVAILABLE" appears on the TV screen, it means no subtitle is recorded on the scene.
- If you choose a language that has a three-letter language code, the code will be displayed every time you change the subtitle language setting. If you choose any other languages, "--" will be displayed instead. (Refer to page 24.)
- Some discs will only allow you to change the subtitle from the disc menu. Refer to the manual accompanying the discs for details.

Audio Language



This unit allows you to select an audio language (if multiple languages are available) during DVD playback.

- 1 Press **[AUDIO]** to change audio language.



Each time you press **[AUDIO]**, audio language changes as example below.



Hint

- Some discs will only allow you to change the audio setting from the disc menu. Refer to the manual accompanying the discs for details.
- When "OFF" appears on the TV screen, it means audio language is not available.
- If your language is not shown after pressing **[AUDIO]** several times, the disc may not have that language. However, some discs allow audio language setting on the disc menu. (Operation varies depending on the disc, so refer to the manual along with the disc.)

Camera Angle



Some DVD discs may contain scenes which have been shot simultaneously from various angles. You can change the camera angle if the angle icon appears on the screen. If the "ANGLE ICON" setting is "OFF" in the OTHERS menu, the angle icon will not appear. (Refer to pages 20-22.)

- 1 Press **[ANGLE]** during playback.



Black Level Setting



Adjust the Black Level Setting to make the dark areas of the TV picture brighter.

- 1 Press **[MODE]** during playback.



- 2 Press **[ENTER]** to adjust the black level.



ON: Makes the dark areas brighter.
OFF: Shows the original picture as recorded.

- 3 Press **[RETURN ↵]** to exit.



Stereo Sound Mode



This unit allows you to select a sound mode during CD playback.

- 1 Press **[AUDIO]** during CD playback.



Each time you press **[AUDIO]**, sound mode changes as example below.

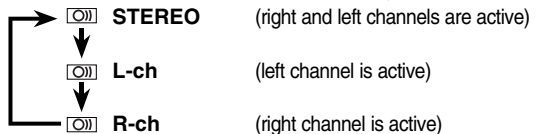

Virtual Surround



You can enjoy stereophonic virtual world on your existing 2 channel stereo system.

- 1 Press **[MODE]** twice (once for CD and MP3) during playback.



- 2 Press **[ENTER]** for the desired effect.

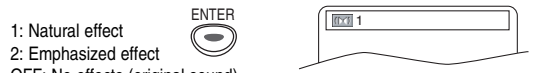

1: Natural effect
2: Emphasized effect
OFF: No effects (original sound)

- 3 Press **[RETURN ↵]** to exit.



Hint

For CD play back only

- Virtual Surround will not be effective if the sound mode is set to something other than STEREO. Refer to "Stereo Sound Mode".
- When playing back 96kHz with Virtual Surround function, the sound will be down sampling at 48kHz and output as digital audio.

QUICK SETUP Menu

You can select the "PLAYER MENU", "TV ASPECT", "PROGRESSIVE" or "DOLBY DIGITAL" from the QUICK SETUP menu quickly.

1 Press [SETUP] in the stop mode.

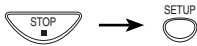

<SETUP MENU>

Confirm that "QUICK" is selected.

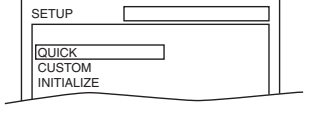

2 Select the desired item.

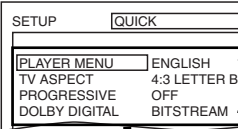
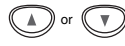

P20 **A** Step 5

P21 **B** Step 5

P21 **C** Step 5

• Refer to the sections "PLAYER MENU", "TV ASPECT", "PROGRESSIVE" or "DOLBY DIGITAL" section on page 20 or 21.

CUSTOM Menu

You can change the settings of the unit.

• **QUICK** on pages 20-21 indicates DVD Setup menus also accessible from the QUICK SETUP menu.

1 Press [SETUP] in the stop mode.

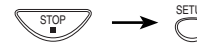

<SETUP MENU>

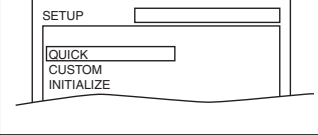

2 Select "CUSTOM".

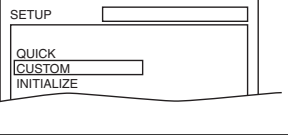
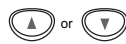

3 Select the desired item.

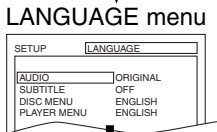
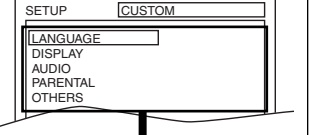
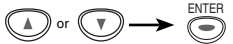

page 20 **A**

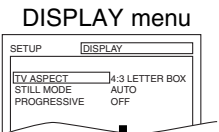

page 21 **B**

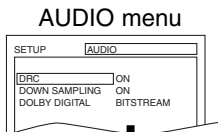

page 21 **C**

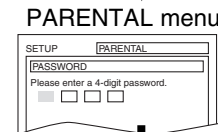

page 22 **D**

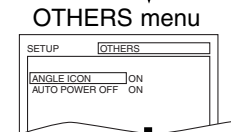

page 22 **E**

A LANGUAGE Setting

Follow steps 1 to 3 in the "CUSTOM Menu" section on above.

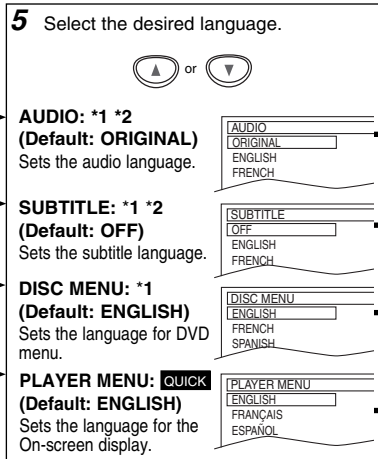
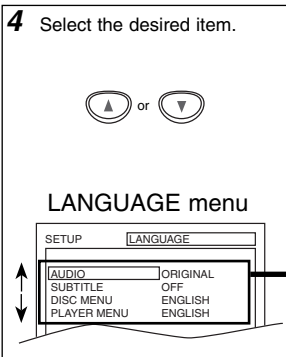

Hint

*1

- Language options are not available with some discs.
- If OTHER is selected on the AUDIO, SUBTITLE or DISC MENU screen, press four-digit number to enter the code for the desired language. (Refer to the language code list on page 24.)
- Only the languages supported by the disc can be selected.

*2

- Language Setting for Audio and Subtitle are not available with some discs. Then use [AUDIO] and [SUBTITLE/T-SET]. Details are on page 19.

B DISPLAY Setting

You can change the display functions. Follow steps 1 to 3 in the "CUSTOM Menu" section on page 20.

4 Select the desired item.

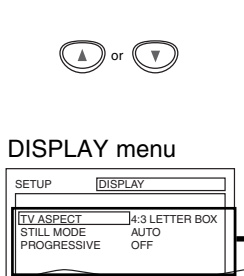

Hint
PROGRESSIVE:

- You can set "PROGRESSIVE" to "OFF" in the DISPLAY menu or press and hold [PLAY] on the front of the unit for more than 5 seconds during playback, so that the P-SCAN indicator on the front panel lights off.
- When "PROGRESSIVE" is "ON", video signals from the unit's VIDEO OUT and S-VIDEO OUT jacks will be distorted or not be output at all.

5

TV ASPECT: QUICK
(Default: 4:3 LETTER BOX)
See Hint on the right.

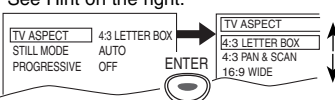

Select the desired setting.

STILL MODE: (Default: AUTO)
See Hint on the right.

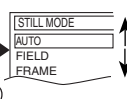

Select the desired setting.

PROGRESSIVE: QUICK
(Default: OFF)
See Hint on the left.

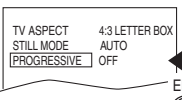

If there is no picture or you do not press any buttons for 15 seconds, Progressive scan will switch to "OFF" and it will exit the setup menu.

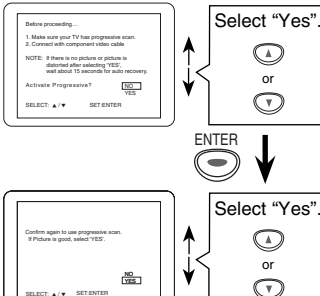

6 To exit the TV ASPECT or STILL MODE screen



To complete the PROGRESSIVE setting



Hint
TV ASPECT:

- Select "4:3 LETTER BOX", so that black bars may appear on the top and bottom of the screen.
- Select "4:3 PAN & SCAN" for a full height picture with both sides adjusted.
- Select "16:9 WIDE" if a wide-screen TV is connected to this unit.

STILL MODE:

- Select "AUTO" usually.
- If you select "AUTO", automatically select the best resolution setting (FRAME or FIELD) based on the data characteristics of the pictures. (default)
- If you select "FIELD", the picture in the still mode will be stabilized.
- If you select "FRAME", the picture in the still mode will be highly defined.
- An individual picture on TV screen is called a "frame", which consists of two separate images called as "field".
- Some pictures may be blurred if you select "AUTO" in the still mode due to their data characteristics.

C AUDIO Setting

Choose the appropriate audio settings for your equipment. It only affects during the playback of DVD discs. Follow steps 1 to 3 in the "CUSTOM Menu" section on page 20.

4 Select the desired item.

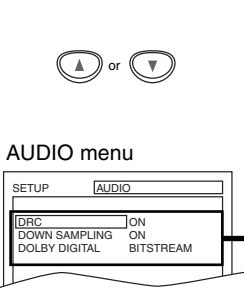

5

DRC (Dynamic Range Control): (Default: ON)
Set to "ON" to compress the range between soft and loud sounds.

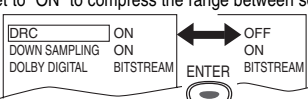

DOWN SAMPLING: (Default: ON)
Set to "ON" when outputting in 48kHz.
Set to "OFF" when outputting the original sound.

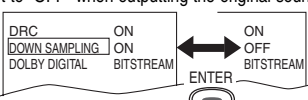

DOLBY DIGITAL: QUICK
(Default: BITSTREAM)
Set to "BITSTREAM" when the unit is connected to a Dolby Digital decoder.

- BITSTREAM: outputs a Dolby Digital Signals.
- PCM: converts the Dolby Digital into PCM (2 channel).

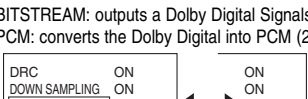

6 To exit the menu

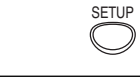

Hint
DRC:

- This function is available only on the discs which are recorded in the Dolby Digital format.

DOWN SAMPLING:

- When playing back a 96kHz disc with the copyright protection, or when Virtual Surround is set to "1" or "2", the sound will be down sampled at 48kHz and output as digital audio even if the "DOWN SAMPLING" is set to "OFF".
- This function is available only on digital outputting of a disc recorded in 96kHz.

D PARENTAL Setting

Parental Control limits the disc viewing that exceed your settings. (An incorrect password will not be acceptable.) This feature prevents your children from viewing inappropriate materials.

Parental Levels

Parental Level allows you to set the rating levels of your DVD discs. Playback will stop if the ratings exceed the levels you set. Follow steps 1 to 3 in the "CUSTOM Menu" section on page 20.

4 Enter your desired four-digit password.

PARENTAL menu

SETUP PARENTAL

PASSWORD

Please enter a 4-digit password.

Or

If you have set a password already, enter the current four-digit password.

SETUP PARENTAL

PASSWORD

Enter current password.

5 Select "PARENTAL LEVEL".

PARENTAL LEVEL ALL

PASSWORD CHANGE

6 Select the desired level.

PARENTAL LEVEL

ALL

8 [ADULT]

7 [NC-17]

6 [R]

7 To exit the menu

SETUP

CONTROL LEVELS

- ALL: All parental locks are canceled.
- Level 8: DVD softwares of any grades (adult/general/children) can be played back.
- Levels 7 to 2: Only DVD softwares intended for general use and children can be played back.
- Level 1: Only DVD softwares intended for children can be played back, with those intended for adult and general use prohibited.

TIPS FOR LEVELS

- 8 [ADULT]: DVD softwares of any grades (adult/general/children) can be played back.
- 7 [NC-17]: No one under 17 admitted
- 6 [R]: Restricted; under 17 requires accompanying parent or adult guardian
- 5 [PGR]: Parental Guidance Recommended
- 4 [PG13]: Unsuitable for children under 13
- 3 [PG]: Parental Guidance suggested
- 2 [G]: General Audience
- 1 [KID SAFE]: Suitable for children

Hint

- DVD-Video discs may not respond to the parental lock settings. Make sure this function works with your DVD-Video discs.

To Change the Password for Parental Controls

You can change your password for parental controls. Follow steps 1 to 3 in the "CUSTOM Menu" section on page 20.

4 Enter current four-digit password.

PARENTAL menu

SETUP PARENTAL

PASSWORD

Enter current password.

5 Select "PASSWORD CHANGE".

PARENTAL LEVEL ALL

PASSWORD CHANGE

6 Enter your new four-digit password (except for 4737).

SETUP PARENTAL

PASSWORD

Please enter a 4-digit password.

7 To exit the menu

SETUP

Hint

- Record the password in case you forget it.
- If you forget the password, press [4], [7], [3], [7] at step 4, then enter your new password. Password will be cleared and parental levels will be set to "ALL".

E OTHERS Setting

You can change the other functions. Follow steps 1 to 3 in the "CUSTOM Menu" section on page 20.

4 Select the desired item.

OTHERS menu

SETUP OTHERS

ANGLE ICON ON

AUTO POWER OFF ON

5 **ANGLE ICON:**
(Default: ON)
Set to "ON" to show the angle icon when multiple camera angles are available during DVD playback.

ANGLE ICON ON OFF

AUTO POWER OFF ON

ENTER

AUTO POWER OFF:
(Default: ON)
Set to "ON" to turn this unit off automatically after 30 minutes of no use.

ANGLE ICON ON ON

AUTO POWER OFF ON OFF

ENTER

6 To exit the menu

SETUP

Reset to the Default Setting (Except for PARENTAL Setting)

1 Press **[SETUP]** in the stop mode.

2 Select "INITIALIZE".

3 Select "YES".

4 To exit the menu

Hint

- When you cancel to initialize at step 3, select "NO".

Information

Troubleshooting Guide

If this unit does not perform properly when operated as instructed in this Owner's Manual, check this unit consulting the following checklist.

	PROBLEM	CORRECTIVE ACTION
DVD / VCR	No power.	<ul style="list-style-type: none"> Make sure the power plug is connected to an AC outlet. Make sure the power is turned on.
	This unit does not respond to the remote control.	<ul style="list-style-type: none"> Check if the power plug is connected to an AC outlet. Check the batteries in the remote control. Aim the remote control directly at the remote sensor. If necessary, remove all the obstacles between the sensor and the remote control. You have to be within 23 feet (7m) of this unit. Check if the right mode is selected. If it's not in the right mode, press [DVD] or [VCR], whichever you need, on the remote control. Check if a cassette tape is in this unit. Tune your radio to an empty AM station so that you hear a lot of noises. Turn the volume up, then if you hear some signal sound from the radio in response to your pressing buttons on the remote control, the remote control is working. Press and hold any button on remote control toward a digital camera. The remote control is working if you confirm infrared light through the digital camera.
	Poor picture or noise.	<ul style="list-style-type: none"> Interference signal may be received. Change the position and orientation of the unit.
VCR	Timer recording is impossible.	<ul style="list-style-type: none"> Make sure the Timer Recording is set correctly. Make sure TIMER REC indicator on the front panel lights up. If not, press [SUBTITLE/T-SET]. Make sure the VCR clock is set correctly.
	Cannot go into record mode.	<ul style="list-style-type: none"> Make sure the tape has a record tab. If needed, cover the hole with adhesive tape. Activate this unit in VCR mode. Press [VCR] on the remote control so that the VCR SOURCE light is lit.
	Playback picture is partially noisy.	<ul style="list-style-type: none"> Adjust tracking control for a better picture by pressing [CHANNEL ▼/▲] on the unit or [SKIP/CH. ►►/◄◄] on the remote control.
	Cannot view a tape but the audio is OK.	<ul style="list-style-type: none"> Head cleaning may be necessary. Refer to "AUTO HEAD CLEANING". Make sure the VCR is not in the Menu mode.
	No or poor, playback picture.	<ul style="list-style-type: none"> Change the RF output channel to CH4. Then select the same channel on the TV. Fine tune your TV.
	TV programs cannot be seen normally.	<ul style="list-style-type: none"> Re-check the ANT-IN and ANT-OUT connections. See the front page and page 6. Press [VCR]. Press [VCR] on the remote control to activate it in the VCR mode. Check if the VCR SOURCE light is lit, then set it to the TV position by pressing [VCR].
	Video or color fades in and out when making a copy of a video tape.	<ul style="list-style-type: none"> You cannot copy a copyrighted video tape. You are experiencing copy guard protection.
Cannot remove the tape.	<ul style="list-style-type: none"> Check if this unit is in the VCR mode. If not, press [VCR] on the remote control to switch the mode. 	
DVD	No picture.	<ul style="list-style-type: none"> Connect the video cable firmly. Insert a correct video disc that plays on this unit. Press [DVD] on the remote control. Check if the DVD SOURCE light is lit. Then try other DVD features. Set PROGRESSIVE correctly. Turn it on only if your TV has progressive scan and you are using the Component Video connections between the unit and the TV. Disable progressive scan for all other connections. (See page 7.)
	Disc cannot be played.	<ul style="list-style-type: none"> Insert the disc. Clean the disc. Place the disc correctly with the label side up. Cancel the parental lock or change the control levels. Handle a disc with special care so that it does not have fingerprints, scratches, or dusts on its surface.
	No sound.	<ul style="list-style-type: none"> Connect the audio cables firmly. Turn the power of the audio component on. Correct the audio output settings. Correct the input settings on the audio component.
	No DTS audio is output	<ul style="list-style-type: none"> This unit does not support DTS audio. -This is not a malfunction.
	Distorted picture.	<ul style="list-style-type: none"> Connect this unit directly to the TV. There are some cases where pictures may be slightly distorted, and those are not a sign of a malfunction. Although pictures may stop for a moment, this is not a malfunction. Check if the INTERLACE/PROGRESSIVE mode is set correctly according to your TV. See pages 20-21.
	Audio or subtitle language does not match the setup.	<ul style="list-style-type: none"> The selected language is not available for audio or subtitles on the DVD. -This is not a malfunction.
	The camera angle cannot be changed.	<ul style="list-style-type: none"> The DVD does not contain sequences recorded from different camera angles. -This is not a malfunction.
	Audio or subtitle language cannot be changed.	<ul style="list-style-type: none"> The DVD does not contain audio source or subtitles in the selected language. -This is not a malfunction.
	"Prohibited icon" appears on the screen, prohibiting an operation.	<ul style="list-style-type: none"> That operation is prohibited by this unit or the disc. -This is not a malfunction.

- Some functions are not available in specific modes, but this is not a malfunction. Read the description in this Owner's Manual for details on correct operations.
- Playback from a desired track and random playback are not available during program playback.
- Some functions are prohibited on some discs.

Specifications

Video Heads : Four Heads	Operating temperature : 41°F (5°C) to 104°F (40°C)	• Designs and specifications are subject to change without notice. • If there is a discrepancy between languages, the default language will be English.
Output signal format : NTSC color	Dimensions : W : 17 3/16" (435mm) H : 3 3/4" (94mm) D : 9 3/16" (233mm)	
Power source : 120 V AC +/- 10%, 60 Hz +/- 0.5%	Weight : Approx 6.0lbs (2.7kg)	

Language Code List

Language	Code	Language	Code	Language	Code	Language	Code
A-B							
Abkhazian	4748	French [FRE]	5264	Macedonian	5957	Siswat	6565
Afar	4747	Frisian	5271	Malagasy	5953	Slovak	6557
Afrikaans	4752	Galician	5358	Malay	5965	Slovenian	6558
Albanian	6563	Georgian	5747	Malayalam	5958	Somali	6561
Amharic	4759	German [GER]	5051	Maltese	5966	Spanish [SPA]	5165
Arabic	4764	Greek [GRE]	5158	Maori	5955	Sundanese	6567
Armenian	5471	Greenlandic	5758	Marathi	5964	Swahili	6569
Assamese	4765	Guarani	5360	Moldavian	5961	Swedish [SWE]	6568
Aymara	4771	Gujarati	5367	Mongolian	5960		T
Azerbaijani	4772	Hausa	5447	Nauru	6047	Tagalog	6658
Bashkir	4847	Hebrew	5569	Nepali	6051	Tajik	6653
Basque	5167	Hindi	5455	Norwegian [NOR]	6061	Tamil	6647
Bengali;Bangla	4860	Hungarian [HUN]	5467			Tatar	6666
Bhutani	5072			O-R		Telugu	6651
Bihari	4854	Icelandic [ICE]	5565	Occitan	6149	Thai	6654
Bislama	4855	Indonesian	5560	Oriya	6164	Tibetan	4861
Breton	4864	Interlingua	5547	Oromo(Afan)	6159	Tigrinya	6655
Bulgarian	4853	Interlingue	5551	Panjabi	6247	Tonga	6661
Burmese	5971	Inupiak	5557	Pashto; Pushto	6265	Tsonga	6665
Byelorussian	4851	Irish [IRI]	5347	Persian	5247	Turkish [TUR]	6664
		Italian [ITA]	5566	Polish [POL]	6258	Turkmen	6657
C-E		Japanese [JPN]	5647	Portuguese [POR]	6266	Twí	6669
Cambodian	5759	Javanese	5669	Quechua	6367		U-Z
Catalan	4947	Kannada	5760	Rhaeto-Romance	6459	Ukrainian	6757
Chinese [CHI]	7254	Kashmiri	5765	Romanian [RUM]	6461	Urdu	6764
Corsican	4961	Kazakh	5757	Russian [RUS]	6557	Uzbek	6772
Croatian	4964	Kinyarwanda	6469			Vietnamese	6855
Czech [CZE]	4965	Kirghiz	5771	S		Volapuk	6861
Danish [DAN]	5047	Kirundi	6460	Samoan	6559	Welsh	4971
Dutch [DUT]	6058	Korean [KOR]	5761	Sango	6553	Wolof	6961
English [ENG]	5160	Kurdish	5767	Sanskrit	6547	Xhosa	7054
Esperanto	5161			Scots Gaelic	6564	Yiddish	5655
Estonian	5166	L-N		Serbian	6554	Yoruba	7161
		Laotian	5861	Serbo-Croatian	6566	Zulu	7267
F-H		Latin	5847	Sesotho	6660		
Faroese	5261	Latvian;Lettish	5868	Setswana	6660		
Fiji	5256	Lingala	5860	Shona	6560		
Finnish [FIN]	5255	Lithuanian	5866	Sindhi	6550		
				Singhalese	6555		

If you choose a Language that has a 3 letter language code, the code will be displayed every time you change the Audio or Subtitle language setting on page 19. If you choose any other languages, "--" will be displayed instead. (3 letter language code is written in bracket.)

PYE VIDEO LIMITED WARRANTY

FUNAI CORP. will repair this product, free of charge in the USA in the event of defect in materials or workmanship as follows:

DURATION:

PARTS: FUNAI CORP. will provide parts to replace defective parts without charge for one (1) year from the date of original retail purchase. Certain parts are excluded from this warranty.

LABOR: FUNAI CORP. will provide the labor without charge for a period of ninety (90) days from the date of original retail purchase.

LIMITS AND EXCLUSIONS:

This warranty is extended only to the original retail purchaser. A purchase receipt or other proof of original retail purchase will be required together with the product to obtain service under this warranty.

This warranty shall not be extended to any other person or transferee.

This warranty is void and of no effect if any serial numbers on the product are altered, replaced, defaced, missing or if service was attempted by an unauthorized service center. This limited warranty does not apply to any product not purchased and used in the United States.

This product is produced for home use and this warranty only covers failures due to defects in material or workmanship which occurs during normal use. It does not cover damage which occurs in shipment, or failures which are caused by repairs, alterations or product not supplied by FUNAI CORP., or damage which results from accident, misuse, abuse, mishandling, misapplication, alteration, faulty installation, improper maintenance, commercial use such as hotel, rental or office use of this product or damage which results from fire, flood, lightning or other acts of God.

THIS WARRANTY DOES NOT COVER PACKING MATERIALS, ANY ACCESSORIES (EXCEPT REMOTE CONTROL), ANY COSMETIC PARTS, COMPLETE ASSEMBLY PARTS, DEMO OR FLOOR MODELS.

FUNAI CORP. AND ITS REPRESENTATIVES OR AGENTS SHALL IN NO EVENT BE LIABLE FOR ANY GENERAL, INDIRECT OR CONSEQUENTIAL DAMAGES ARISING OUT OF OR OCCASIONED BY THE USE OF OR THE INABILITY TO USE THIS PRODUCT. THIS WARRANTY IS MADE IN LIEU

OF ALL OTHER WARRANTIES, EXPRESS OR IMPLIED, AND OF ALL OTHER LIABILITIES ON THE PART OF FUNAI, ALL OTHER WARRANTIES INCLUDING THE WARRANTY OF MERCHANTABILITY, AND FITNESS FOR A PARTICULAR PURPOSE, ARE HEREBY DISCLAIMED BY FUNAI AND ITS REPRESENTATIVES IN THE UNITED STATES. ALL WARRANTY INSPECTIONS AND REPAIRS MUST BE PERFORMED BY AN AUTHORIZED SERVICE CENTER. THIS WARRANTY IS VALID WHEN THE UNIT IS CARRIED-IN TO AN AUTHORIZED SERVICE CENTER.

IMPORTANT:

THIS LIMITED WARRANTY GIVES YOU SPECIFIC LEGAL RIGHTS. YOU MAY HAVE OTHER RIGHTS THAT VARY FROM STATE TO STATE. IF, AT ANY TIME DURING THE WARRANTY PERIOD, YOU ARE UNABLE TO OBTAIN SATISFACTION WITH THE REPAIR OF THIS PRODUCT, PLEASE CONTACT FUNAI CORP.

ATTENTION:

FUNAI CORP. RESERVES THE RIGHT TO MODIFY ANY DESIGN OF THIS PRODUCT WITHOUT PRIOR NOTICE.

WARRANTY STATEMENT REGARDING NON AUTHORIZED REPAIRS:

To obtain warranty service, you must take the product, or deliver the product freight prepaid, in either its original packaging or packaging affording an equal degree of protection, to any AUTHORIZED SERVICE CENTER. FUNAI CORP. will not reimburse you for any service done by unauthorized service providers without prior written approval.

To locate your nearest AUTHORIZED SERVICE CENTER or for general service inquiries, please contact us at:

FUNAI CORPORATION
Customer Service

Tel : 1-800-789-4230

<http://www.funai-corp.com>

19900 Van Ness Avenue, Torrance, CA 90501

1 Conexiones

Consulte la "Basic TV Connection" en la página delantera antes de utilizar esta unidad.

Canal de salida RF

Si el canal 3 se está utilizando para una transmisión,

- 1) Programe su televisor al canal 4.
- 2) Inserte una cinta pregrabada en esta unidad.
- 3) Pulse **[SOURCE]** en la unidad para que se encienda la luz VCR SOURCE.
 - Si aparece ruido en la pantalla de TV, presione **[VCR/TV]** en el mando a distancia.
- 4) Pulse una vez **[PLAY ►]**.
- 5) Después de unos segundos, pulse **[PLAY ►]** en la unidad durante 3 segundos.
 - El canal de salida RF cambiará del canal 3 al canal 4 y podrá ver una imagen reproducida.
 - Cuando no aparezca una imagen en la pantalla del televisor, repita el paso 4.
- 6) Pulse **[STOP ■]** para parar la reproducción.

2 Instalación de las pilas del control remoto



3 Conmutación VCR/DVD

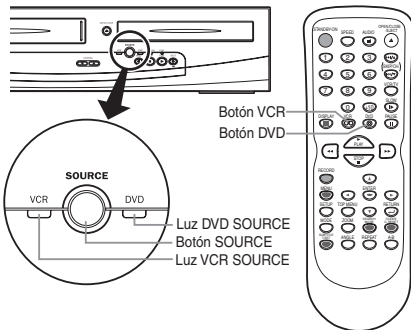

MODO VCR

Pulse **[VCR]** en el control remoto. (Compruebe que está encendida la luz VCR SOURCE.)

MODO DVD

Pulse **[DVD]** en el control remoto. (Compruebe que está encendida la luz DVD SOURCE.)

Consejo

- Si pulsa sólo **[SOURCE]** en el panel frontal NO cambia el modo del control remoto. DEBE seleccionar también el modo correcto en el control remoto.

4 Activación de la unidad por primera vez



- 1 Encienda el televisor y sintonice al canal 3.

- Si el canal 3 se está utilizando para una transmisión, vea la sección "Canal de salida RF".

2

STANDBY-ON

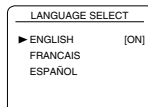

- 3 Pulse **[►]** para AJUSTE AUTO.

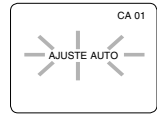

Conecta el cable de la caja de canales de cable o la caja de satélite en la toma ANT-IN de la unidad?

SI

NO

Si Pulse **[MENU]** para salir.

No Espere unos minutos.

Después del escaneo

- El sintonizador se detiene en el canal memorizado más bajo.
- Puede seleccionar sólo los canales memorizados en esta unidad con **[SKIP/CH. ►/▲, ◀/▼]** (o **[CHANNEL ▲/▼]**).
- Si aparece nuevamente "AJUSTE AUTO" en la pantalla de TV, verifique las conexiones de cable. Presione nuevamente **[►]**.

5 Ajuste del reloj



1



- Si no se ha ajustado el reloj, aparece la pantalla AJUSTE DE RELOJ cuando pulse **[MENU]**. En este caso, vaya al paso 2.

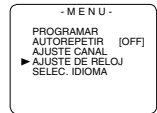

- 2 Seleccione el mes actual.

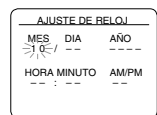

- 3 Seleccione el día actual.

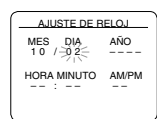

- 4 Seleccione el año actual.

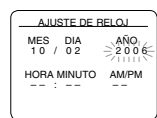

- 5 Seleccione la hora actual.

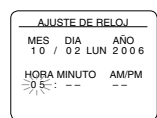

- 6 Seleccione los minutos actuales.

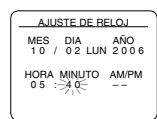

- 7 Seleccione "AM" o "PM".

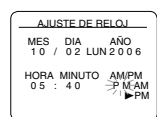

- 8 Para salir de la pantalla AJUSTE DE RELOJ



6 Reproducción de la grabadora de vídeo

Antes: Encienda el televisor y cambie al canal 3.

- Si el canal 3 se está utilizando para una transmisión, vea la sección "Canal de salida RF".



1	2 Para empezar la reproducción
3 Para parar la reproducción	4 Para expulsar

7 Reproducción de DVD/CD

Antes: Encienda el televisor, amplificador y otros equipos que puedan estar conectados a esta unidad. Asegúrese que el televisor y el sintonizador de audio (de venta en los comercios) están en el canal correcto.



1	2
	Ponga un disco con la etiqueta hacia arriba.
3 Para empezar la reproducción	4 Para parar la reproducción

8 Control remoto

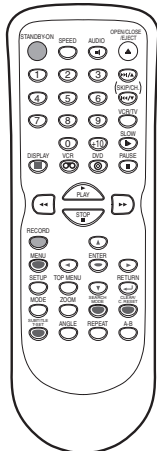

Botón (Orden alfabético)	Modo DVD			Modo de grabadora de vídeo
	• Para seleccionar directamente el capítulo o el título.	• Para seleccionar directamente la canción.		• Para seleccionar el canal. • El botón +10 no tiene efecto en el modo de grabadora de vídeo.
	• Para buscar en avance/retroceso en un disco. • Para empezar la reproducción en avance/retroceso lento durante el modo de pausa.	• Para buscar en avance/retroceso en un disco.		• Para el avance/retroceso de una cinta.
	• Para repetir entre los puntos A y B elegidos.	• Para repetir entre los puntos A y B elegidos. (CD)		—
	• Para seleccionar los ángulos de la cámara en un disco.	—		—
	• Para seleccionar el idioma de audio en un disco.	• Para seleccionar ESTÉREO, L-ch o R-ch. (CD)		—
	• Para borrar los marcadores. • Para borrar los números entrados incorrectamente. • Para borrar el punto para la repetición A-B.	• Para borrar los marcadores. (CD) • Para retirar el N° de estado en la entrada de programa. • Para borrar los números entrados incorrectamente. • Para borrar el punto para la repetición A-B. (CD)		• Para salir del menú de la grabadora de vídeo. • Para reponer el contador de cinta.
	• Para indicar el modo de disco actual.	• Para indicar el modo de disco actual.		• Para indicar la hora actual, contador de cinta y canal.
	• Para seleccionar el modo de salida de DVD. • Para activar el mando a distancia en el modo DVD.	• Para seleccionar el modo de salida de DVD. • Para activar el mando a distancia en el modo DVD.		—
	• Para mover el cursor y determinar su posición.	• Para mover el cursor y determinar su posición.		• Para seleccionar un ítem en el menú de la grabadora de vídeo. • Para avanzar al siguiente menú de la grabadora de vídeo. • Para volver un paso durante el ajuste del reloj y temporizador.
	• Para llamar el menú en un disco.	• Para llamar la lista de archivo. (MP3)		• Para llamar el menú de la grabadora de vídeo.
	• Para activar/desactivar el nivel del negro. • Para activar/desactivar el envoltorio virtual.	• Para disponer el orden de reproducción o la reproducción aleatoria. • Para activar/desactivar el envoltorio virtual.		—
	• Para abrir o cerrar la bandeja del disco.	• Para abrir o cerrar la bandeja del disco.		• Para expulsar el videocasete de la grabadora de vídeo.
	• Para hacer una pausa de reproducción del disco. • Para avanzar la reproducción un cuadro a la vez.	• Para hacer una pausa en la reproducción del disco.		• Para hacer una pausa de la reproducción o grabación de la cinta. • Para avanzar la reproducción un cuadro a la vez.
	• Para empezar la reproducción del disco.	• Para empezar la reproducción del disco.		• Para empezar la reproducción de la cinta.
	—	—		• Para empezar una grabación o una grabación de un toque.
	• Para reproducir repetidamente un capítulo o título.	• Para reproducir repetidamente una canción o disco. (CD) • Para reproducir repetidamente una canción, grupo o disco. (MP3)		—
	• Para volver a la operación previa en el menú.	• Para volver a la operación previa en el menú.		—
	• Para buscar un capítulo, título u hora. • Para colocar o buscar los marcadores.	• Para buscar una canción. • Para buscar la hora. (CD) • Para colocar o buscar los marcadores. (CD)		• Para llamar el menú de búsqueda de índice u hora.
	• Para llamar el menú de programación de DVD.	• Para llamar el menú de programación de DVD.		—
	• Para saltar capítulos o título.	• Para saltar canciones.		• Para cambiar de canal. • Para ajustar manualmente el seguimiento durante la reproducción.
	—	—		• Para ver la cinta en cámara lenta.
	—	—		• Para seleccionar la velocidad de grabación.
	• Para encender o apagar la unidad.	• Para encender o apagar la unidad.		• Para encender o apagar la unidad.
	• Para parar la reproducción.	• Para parar la reproducción.		• Para parar la reproducción o grabación.
	• Para seleccionar subtítulos en un disco.	—		• Para poner la grabadora de vídeo en el modo de espera para una grabación con temporizador.
	• Para llamar el menú superior en un disco.	• Para volver al archivo superior de la jerarquía más alta en el programa y en la lista de archivo. (MP3)		—
	—	—		• Para seleccionar el modo de salida de la grabadora de vídeo. • Para activar el mando a distancia en el modo de la grabadora de vídeo.
	• Para seleccionar la posición de DVD o posición del televisor.	• Para seleccionar la posición de CD/MP3 o la posición del televisor.		• Para seleccionar la posición de la grabadora de vídeo o posición del televisor.
	• Para ampliar parte de la imagen. (x2/x4)	—		—

Quick Use Guide

1 Connections

Please refer to "Basic TV Connection" on the front page before you use this unit.

RF Output Channel

If channel 3 has been already occupied for broadcasting,

- 1) Set your TV to channel 4.
- 2) Insert a pre-recorded tape into this unit.
- 3) Press **[SOURCE]** on the unit so that the VCR SOURCE light is lit.
 - If noise appears on the TV screen, press **[VCR/TV]** on the remote control.
- 4) Press **[PLAY ▶]** once.
- 5) After a few seconds, press and hold **[PLAY ▶]** on the unit for 3 seconds.
 - The RF output channel will change to channel 4 from channel 3 and you will see a playback picture.
 - When a picture does not appear on the TV screen, repeat step 4.
- 6) Press **[STOP ■]** to stop playback.

2 Installing the Batteries for the Remote Control



3 VCR/DVD Switching

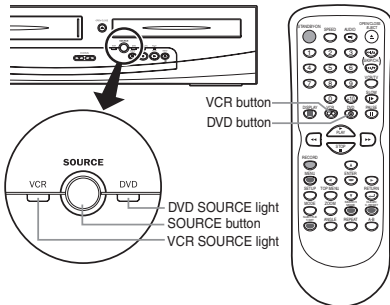

VCR MODE

Press **[VCR]** on the remote control. (Verify that the VCR SOURCE light is lit.)

DVD MODE

Press **[DVD]** on the remote control. (Verify that the DVD SOURCE light is lit.)

Hint

- Pressing only **[SOURCE]** on the front panel DOES NOT switch the mode of the remote control. You MUST select the correct mode on the remote control.

4 Turn on the Unit for the First Time



- 1 Turn on the TV and set it to channel 3.
 - If channel 3 has been already occupied for broadcasting, see "RF Output Channel" section.



- 2 Select your language in the first time you turn on this unit.

Then press **[▶]** to go to next step.

STANDBY-ON

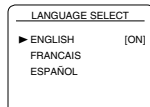
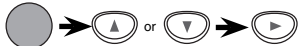

- 3 Press **[▶]** to start Auto Set Up.

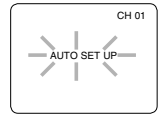

Do you connect the cable from the cable box or the satellite box to the unit's ANT-IN jack?

YES

NO

Yes Press **[MENU]** to exit.

No Please wait for a few minutes.

After scanning...

- The tuner stops on the lowest memorized channel.
- You can select only the channels memorized in this unit by using **[SKIP/CH. ▶▶/▲, ◀◀/▼]** (or **[CHANNEL ▲/▼]**).
- If "AUTO SET UP" appears on the TV screen again, check the cable connections. Then, press **[▶]** once again.

5 Clock Set Up



- 1 Press **[MENU]** and select "CLOCK SET". Then press **[▶]** to go to next step.

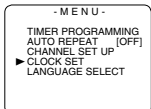

- If the clock is not set, the CLOCK SET screen appears when you press **[MENU]**. In this case, go to step 2.

- 2 Select the current month.

Then press **[▶]** to go to next step.

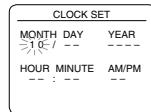

- 3 Select the current day.

Then press **[▶]** to go to next step.

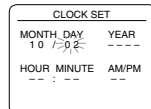

- 4 Select the current year.

Then press **[▶]** to go to next step.

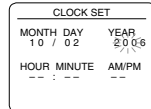

- 5 Select the current hour.

Then press **[▶]** to go to next step.

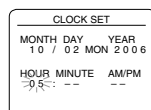

- 6 Select the current minute.

Then press **[▶]** to go to next step.

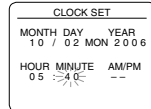

- 7 Select "AM" or "PM".

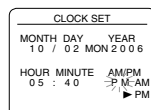
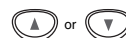

- 8 To exit the CLOCK SET screen



Quick Use Guide

6 VCR Playback

Before: Turn on the TV and set it to channel 3.

- If channel 3 has been already occupied for broadcasting, see "RF Output Channel" section.



1 Insert a video cassette into this unit. 	2 To start playback
3 To stop playback 	4 To eject the cassette

7 DVD/CD Playback

Before: Turn on the TV, amplifier and any other components which are connected to this unit. Make sure the TV and audio receiver (commercially available) are set to the correct channel.



1 →	2 Insert a disc with label facing up.
3 To start playback 	4 To stop playback

8 Remote Control

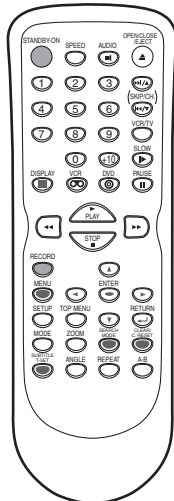

Button (Alphabetical order)	Disc/Tape	DVD mode		VCR mode
		• To select chapter or title directly.	• To select track directly.	• To select channel. • The +10 button has no effect in VCR mode.
		• To search forward/backward through a disc. • To begin slow forward/reverse playback in the pause mode.	• To search forward/backward through a disc.	• To forward/backward a tape.
		• To repeat between your chosen point A and B.	• To repeat between your chosen point A and B. (CD)	—
		• To select camera angles on a disc.	—	—
		• To select audio languages on a disc.	• To select STEREO, L-ch or R-ch. (CD)	—
		• To clear the markers. • To clear the numbers entered incorrectly. • To cancel the point for A-B repeat.	• To clear the markers. (CD) • To remove status number in program input. • To clear the numbers entered incorrectly. • To cancel the point for A-B repeat. (CD)	• To exit the VCR Menu. • To reset the tape counter.
		• To display the current disc mode.	• To display the current disc mode.	• To display the current time, tape counter, and channel.
		• To select the DVD output mode. • To activate the remote control in DVD mode.	• To select the DVD output mode. • To activate the remote control in DVD mode.	—
		• To move the cursor and determine its position.	• To move the cursor and determine its position.	• To select an item on the VCR Menu. • To advance to the next VCR Menu. • To go back one step during clock and timer setting.
		• To call up the Menu on a disc.	• To call up the file list. (MP3)	• To call up the VCR Menu.
		• To set black level on/off. • To set virtual surround on/off.	• To arrange the playing order or play randomly. • To set virtual surround on/off.	—
		• To open or close the disc tray.	• To open or close the disc tray.	• To eject the video cassette from the VCR.
		• To pause disc playback. • To advance playback one frame at a time.	• To pause disc playback.	• To pause tape playback or recording. • To advance playback one frame at a time.
		• To begin disc playback.	• To begin disc playback.	• To begin tape playback.
		—	—	• To start a recording or One Touch Recording.
		• To play a chapter or title repeatedly.	• To play a track or disc repeatedly. (CD) • To play a track, group or disc repeatedly. (MP3)	—
		• To return to the previous operation in menu.	• To return to the previous operation in menu.	—
		• To search chapter, title or time. • To set or search the markers.	• To search track. • To search time. (CD) • To set or search the markers. (CD)	• To call up the index or time search menu.
		• To call up the DVD setup menu.	• To call up the DVD setup menu.	—
		• To skip chapters or titles.	• To skip tracks.	• To change channels. • To adjust the tracking manually during playback.
		—	—	• To view the tape in slow motion.
		—	—	• To select the recording speed.
		• To turn the unit on/off.	• To turn the unit on/off.	• To turn the unit on/off.
		• To stop playback.	• To stop playback.	• To stop playback or recording.
		• To select subtitles on a disc.	—	• To put the VCR into standby mode for a Timer Recording.
		• To call up the Top Menu on a disc.	• To return to the top file of the highest hierarchy in the program and file list. (MP3)	—
		—	—	• To select the VCR output mode. • To activate the remote control in VCR mode.
		• To select DVD position or TV position.	• To select CD/MP3 position or TV position.	• To select VCR position or TV position.
		• To magnify part of a picture. (x2/x4)	—	—